



PRELIMINARY

M28F008 8 MBIT (1 MBIT x 8) FLASH MEMORY

- **High-Density Symmetrically Blocked Architecture**
 - Sixteen 64 Kbyte Blocks
- **Extended Cycling Capability**
 - 10K Block Erase Cycles Minimum
 - 160K Block Erase Cycles per Chip
- **Automated Byte Write and Block Erase**
 - Command User Interface
 - Status Register
- **System Performance Enhancements**
 - RY/ \overline{BY} Status Output
 - Erase Suspend Capability
- **SRAM-Compatible Write Interface**
- **Very High-Performance Read**
 - 100 ns Maximum Access Time
- **Hardware Data Protection Feature**
 - Erase/Write Lockout during Power Transitions
- **Industry Standard Packaging**
 - 40-Lead Sidebraced DIP
 - 42-Lead Flatpack
- **ETOX™ Nonvolatile Flash Technology**
 - 12V Byte Write/Block Erase
- **Independent Software Vendor Support**
 - Microsoft* Flash File System (FFS)

Intel's M28F008 8-Mbit FlashFile Memory is the highest density nonvolatile read/write solution for solid state storage. The M28F008's extended cycling, symmetrically blocked architecture, fast access time, write automation and low power consumption provide a more reliable, lower power, lighter weight and higher performance alternative to traditional rotating disk technology. The M28F008 brings new capabilities to portable computing. Application and operating system software stored in resident flash memory arrays provide instant-on, rapid execute-in-place and protection from obsolescence through in-system software updates. Resident software also extends system battery life and increases reliability by reducing disk drive accesses.

For high-density data acquisition applications, the M28F008 offers a more cost-effective and reliable alternative to SRAM and battery. Traditional high density embedded applications, such as telecommunications, can take advantage of the M28F008's nonvolatility, blocking and minimal system code requirements for flexible firmware and modular software designs.

The M28F008 is offered in 40-lead sidebraced DIP and 42-lead Flatpack packages. This device uses an integrated Command User Interface and state machine for simplified block erasure and byte write. The M28F008 memory map consists of 16 separately erasable 64 Kbyte blocks.

Intel's M28F008 employs advanced CMOS circuitry for systems requiring low power consumption and noise immunity. Its 100 ns access time provides superior performance when compared with magnetic storage media. A deep powerdown mode lowers power consumption to 500 μ W maximum thru V_{CC} . The RP power control input also provides absolute data protection during system powerup/down.

Manufactured on Intel's ETOX process technology, the M28F008 provides the highest levels of quality, reliability and cost-effectiveness.

*Microsoft is a trademark of Microsoft Corporation.

*Other brands and names are the property of their respective owners.
Information in this document is provided in connection with Intel products. Intel assumes no liability whatsoever, including infringement of any patent or copyright, for sale and use of Intel products except as provided in Intel's Terms and Conditions of Sale for such products. Intel retains the right to make changes to these specifications at any time, without notice. Microcomputer Products may have minor variations to this specification known as errata.
COPYRIGHT © INTEL CORPORATION, 1995
November 1994
Order Number: 271232-004

PRODUCT OVERVIEW

The M28F008 is a high-performance **8 Mbit** (8,388,608 bit) memory organized as **1 Mbyte** (1,048,576 bytes) of 8 bits each. **Sixteen 64 Kbyte** (65,536 byte) **blocks** are included on the M28F008. A memory map is shown in Figure 4 of this specification. A block erase operation erases one of the sixteen blocks of memory in typically **1.6 seconds**, independent of the remaining blocks. Each block can be independently erased and written **10,000 cycles**. **Erase Suspend** mode allows system software to suspend block erase to read data or execute code from any other block of the M28F008.

The M28F008 is available in **40-lead sidebrazed DIP** and **42-lead Flatpack** packages. Pinouts are shown in Figures 2a and 2b of this specification.

The **Command User Interface** serves as the interface between the microprocessor or microcontroller and the internal operation of the M28F008.

Byte Write and Block Erase Automation allow byte write and block erase operations to be executed using a two-write command sequence to the Command User Interface. The internal **Write State Machine** (WSM) automatically executes the algorithms and timings necessary for byte write and block erase operations, including verifications, thereby unburdening the microprocessor or microcontroller. Writing of memory data is performed in byte increments typically within **9 μ s**, an 80% improvement over current flash memory products. **I_{pp} byte write and block erase currents** are **30 mA maximum**. **V_{pp} byte write and block erase voltage** is **11.4V to 12.6V**.

The **Status Register** indicates the status of the WSM and when the WSM successfully completes the desired byte write or block erase operation.

The **RY/BY** output gives an additional indicator of WSM activity, providing capability for both hardware signal of status (versus software polling) and status masking (interrupt masking for background erase, for example). Status polling using RY/BY minimizes both CPU overhead and system power consumption. When low, RY/BY indicates that the WSM is performing a block erase or byte write operation. RY/BY high indicates that the WSM is ready for new commands, block erase is suspended or the device is in deep powerdown mode.

Maximum access time is **100 ns (t_{ACC})** over the military temperature range (-55°C to $+125^{\circ}\text{C}$) and over V_{CC} supply voltage range 4.5V to 5.5V. **I_{CC} active current** (CMOS Read) is **35 mA maximum at 8 MHz**.

When the $\overline{\text{CE}}$ and $\overline{\text{RP}}$ pins are at V_{CC}, the **I_{CC} CMOS Standby** mode is enabled.

A **Deep Powerdown** mode is enabled when the $\overline{\text{RP}}$ pin is at GND, minimizing power consumption and providing write protection. **I_{CC} current** in deep powerdown is **100 μ A maximum**. Reset time of 400 ns is required from $\overline{\text{RP}}$ switching high until outputs are valid to read attempts. Equivalently, the device has a wake time of 1 μ s from $\overline{\text{RP}}$ high until writes to the Command User Interface are recognized by the M28F008. With $\overline{\text{RP}}$ at GND, the WSM is reset and the Status Register is cleared.

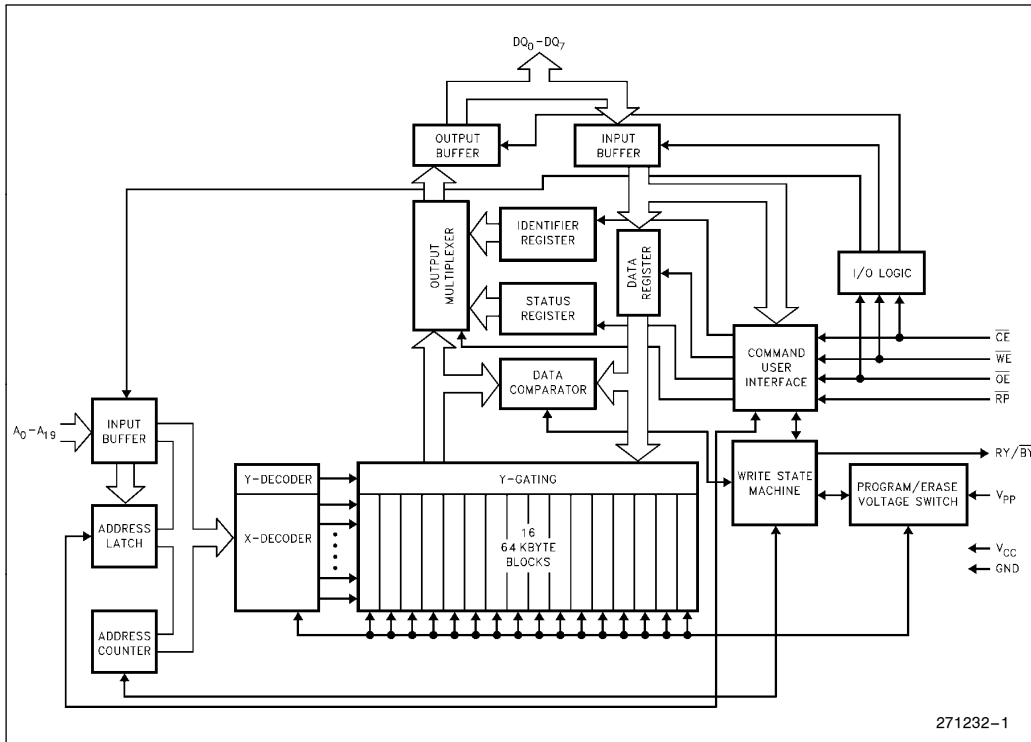

Figure 1. Block Diagram

Table 1. Pin Description

Symbol	Type	Name and Function
A ₀ -A ₁₉	INPUT	ADDRESS INPUTS for memory addresses. Addresses are internally latched during a write cycle.
DQ ₀ -DQ ₇	INPUT/OUTPUT	DATA INPUT/OUTPUTS: Inputs data and commands during Command User Interface write cycles; outputs data during memory array, Status Register and Identifier read cycles. The data pins are active high and float to tri-state off when the chip is deselected or the outputs are disabled. Data is internally latched during a write cycle.
\overline{CE}	INPUT	CHIP ENABLE: Activates the device's control logic, input buffers, decoders, and sense amplifiers. \overline{CE} is active low; \overline{CE} high deselects the memory device and reduces power consumption to standby levels.
\overline{RP}	INPUT	RESET/DEEP POWERDOWN: Puts the device in deep powerdown mode. \overline{RP} is active low; \overline{RP} high gates normal operation. \overline{RP} also locks out block erase or byte write operations when active low, providing data protection during power transitions. \overline{RP} active resets internal automation. Exit from Deep Powerdown sets device to read-array mode.
\overline{OE}	INPUT	OUTPUT ENABLE: Gates the device's outputs through the data buffers during a read cycle. \overline{OE} is active low.
\overline{WE}	INPUT	WRITE ENABLE: Controls writes to the Command User Interface and array blocks. \overline{WE} is active low. Addresses and data are latched on the rising edge of the \overline{WE} pulse.

Table 1. Pin Description (Continued)

Symbol	Type	Name and Function
RY/ $\overline{\text{BY}}$	OUTPUT	READY/$\overline{\text{BUSY}}$: Indicates the status of the internal Write State Machine. When low, it indicates that the WSM is performing a block erase or byte write operation. RY/ $\overline{\text{BY}}$ high indicates that the WSM is ready for new commands, block erase is suspended or the device is in deep powerdown mode. RY/ $\overline{\text{BY}}$ is always active and does NOT float to tri-state off when the chip is deselected or data outputs are disabled.
V _{PP}		BLOCK ERASE/BYTE WRITE POWER SUPPLY for erasing blocks of the array or writing bytes of each block. NOTE: With V _{PP} < V _{PPLMAX} , memory contents cannot be altered.
V _{CC}		DEVICE POWER SUPPLY (5V ± 10%)
GND		GROUND

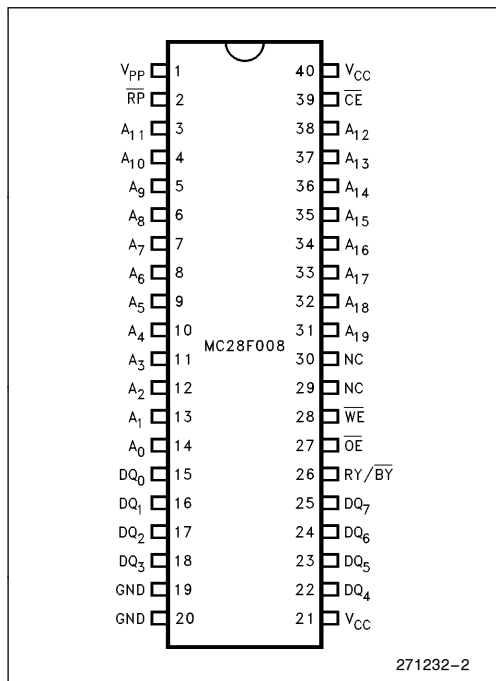

Figure 2a. DIP Pinout

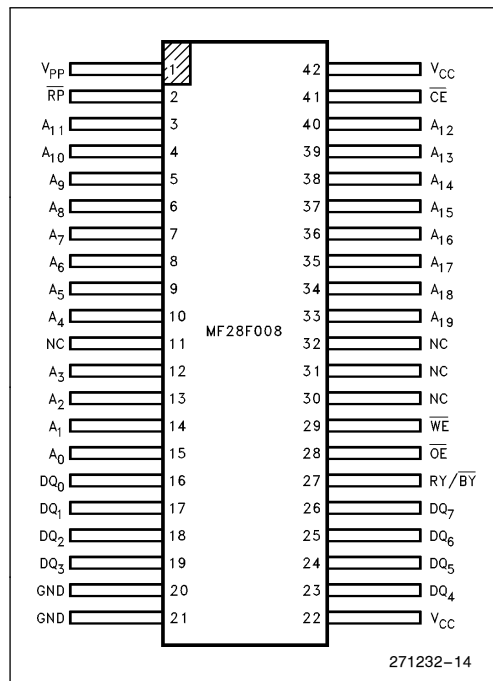

Figure 2b. Flatpack Pinout

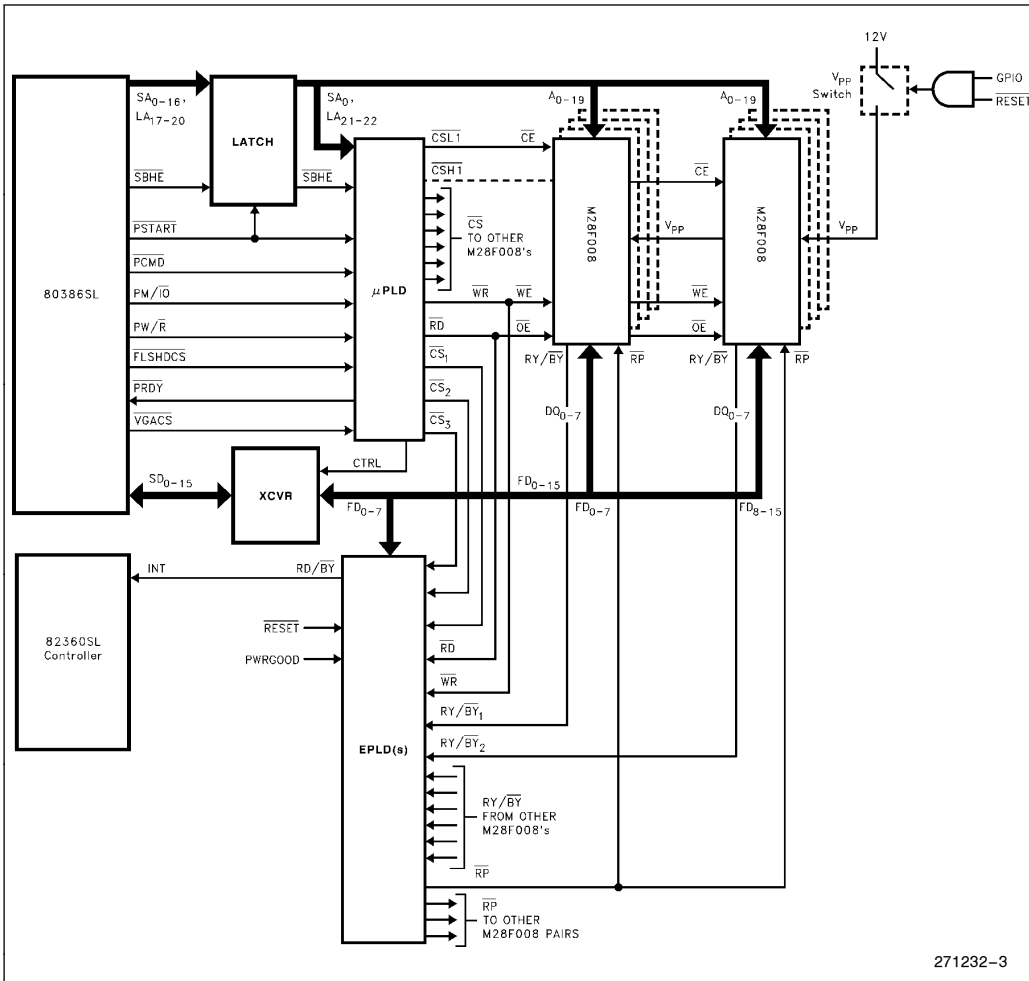

Figure 3. M28F008 Array Interface to Intel386™ SL Microprocessor Superset through PI Bus (Including RY/BY Masking and Selective Powerdown), for DRAM Backup during System SUSPEND, Resident O/S and Applications and Motherboard Solid-State Disk.

PRINCIPLES OF OPERATION

The M28F008 includes on-chip write automation to manage write and erase functions. The Write State Machine allows for: 100% TTL-level control inputs, fixed power supplies during block erasure and byte write, and minimal processor overhead with RAM-like interface timings.

After initial device powerup, or after return from deep powerdown mode (see Bus Operations), the M28F008 functions as a read-only memory. Manipulation of external memory-control pins allow array read, standby and output disable operations. Both Status Register and intelligent identifier can

also be accessed through the Command User Interface when $V_{PP} = V_{PPL}$.

This same subset of operations is also available when high voltage is applied to the V_{PP} pin. In addition, high voltage on V_{PP} enables successful block erasure and byte writing of the device. All functions associated with altering memory contents—byte write, block erase, status and intelligent identifier—are accessed via the Command User Interface and verified thru the Status Register.

Commands are written using standard microprocessor write timings. Command User Interface contents serve as input to the WSM, which controls the block

erase and byte write circuitry. Write cycles also internally latch addresses and data needed for byte write or block erase operations. With the appropriate command written to the register, standard microprocessor read timings output array data, access the intelligent identifier codes, or output byte write and block erase status for verification.

Interface software to initiate and poll progress of internal byte write and block erase can be stored in any of the M28F008 blocks. This code is copied to, and executed from, system RAM during actual flash memory update. After successful completion of byte write and/or block erase, code/data reads from the M28F008 are again possible via the Read Array command. Erase suspend/resume capability allows system software to suspend block erase to read data and execute code from any other block.

FFFFF	64 Kbyte Block
F0000	
EFFFF	64 Kbyte Block
E0000	
DFFFF	64 Kbyte Block
D0000	
CFFFF	64 Kbyte Block
C0000	
BFFFF	64 Kbyte Block
B0000	
AFFFF	64 Kbyte Block
A0000	
9FFFF	64 Kbyte Block
90000	
8FFFF	64 Kbyte Block
80000	
7FFFF	64 Kbyte Block
70000	
6FFFF	64 Kbyte Block
60000	
5FFFF	64 Kbyte Block
50000	
4FFFF	64 Kbyte Block
40000	
3FFFF	64 Kbyte Block
30000	
2FFFF	64 Kbyte Block
20000	
1FFFF	64 Kbyte Block
10000	
0FFFF	64 Kbyte Block
00000	

Figure 4. Memory Map

Command User Interface and Write Automation

An on-chip state machine controls block erase and byte write, freeing the system processor for other tasks. After receiving the Erase Setup and Erase Confirm commands, the state machine controls block pre-conditioning and erase, returning progress via the Status Register and RY/B \bar{Y} output. Byte write is similarly controlled, after destination address and expected data are supplied. The program and erase algorithms of past Intel Flash memories are now regulated by the state machine, including pulse repetition where required and internal verification and margining of data.

Data Protection

Depending on the application, the system designer may choose to make the V_{PP} power supply switchable (available only when memory byte writes/block erases are required) or hardwired to V_{PPH} . When $V_{PP} = V_{PPL}$, memory contents cannot be altered. The M28F008 Command User Interface architecture provides protection from unwanted byte write or block erase operations even when high voltage is applied to V_{PP} . Additionally, all functions are disabled whenever V_{CC} is below the write lockout voltage V_{LKO} , or when $\bar{R}\bar{P}$ is at V_{IL} . The M28F008 accommodates either design practice and encourages optimization of the processor-memory interface.

The two-step byte write/block erase Command User Interface write sequence provides additional software write protection.

BUS OPERATION

Flash memory reads, erases and writes in-system via the local CPU. All bus cycles to or from the flash memory conform to standard microprocessor bus cycles.

Read

The M28F008 has three read modes. The memory can be read from any of its blocks, and information can be read from the intelligent identifier or Status Register. V_{PP} can be at either V_{PPL} or V_{PPH} .

The first task is to write the appropriate read mode command to the Command User Interface (array, intelligent identifier, or Status Register). The M28F008 automatically resets to Read Array mode upon initial device powerup or after exit from deep powerdown. The M28F008 has four control pins, two of which

Table 2. Bus Operations

Mode	Notes	\overline{RP}	\overline{CE}	\overline{OE}	\overline{WE}	A_0	V_{PP}	DQ_{0-7}	RY/\overline{BY}
Read	1, 2, 3	V_{IH}	V_{IL}	V_{IL}	V_{IH}	X	X	D_{OUT}	X
Output Disable	3	V_{IH}	V_{IL}	V_{IH}	V_{IH}	X	X	High Z	X
Standby	3	V_{IH}	V_{IH}	X	X	X	X	High Z	X
PowerDown		V_{IL}	X	X	X	X	X	High Z	V_{OH}
Intelligent Identifier (Mfr)		V_{IH}	V_{IL}	V_{IL}	V_{IH}	V_{IL}	X	89H	V_{OH}
Intelligent Identifier (Device)		V_{IH}	V_{IL}	V_{IL}	V_{IH}	V_{IH}	X	A2H	V_{OH}
Write	3, 4, 5	V_{IH}	V_{IL}	V_{IH}	V_{IL}	X	X	D_{IN}	X

NOTES:

1. Refer to DC Characteristics. When $V_{PP} = V_{PPL}$, memory contents can be read but not written or erased.
2. X can be V_{IL} or V_{IH} for control pins and addresses, and V_{PPL} or V_{PPH} for V_{PP} . See DC Characteristics for V_{PPL} and V_{PPH} voltages.
3. RY/\overline{BY} is V_{OL} when the Write State Machine is executing internal block erase or byte write algorithms. It is V_{OH} when the WSM is not busy, in Erase Suspend mode or deep powerdown mode.
4. Command writes involving block erase or byte write are only successfully executed when $V_{PP} = V_{PPH}$.
5. Refer to Table 3 for valid D_{IN} during a write operation.

must be logically active to obtain data at the outputs. Chip Enable (\overline{CE}) is the device selection control, and when active enables the selected memory device. Output Enable (\overline{OE}) is the data input/output (DQ_0 – DQ_7) direction control, and when active drives data from the selected memory onto the I/O bus. \overline{RP} and \overline{WE} must also be at V_{IH} . Figure 8 illustrates read bus cycle waveforms.

Output Disable

With \overline{OE} at a logic-high level (V_{IH}), the device outputs are disabled. Output pins (DQ_0 – DQ_7) are placed in a high-impedance state.

Standby

\overline{CE} at a logic-high level (V_{IH}) places the M28F008 in standby mode. Standby operation disables much of the M28F008's circuitry and substantially reduces device power consumption. The outputs (DQ_0 – DQ_7) are placed in a high-impedance state independent of the status of \overline{OE} . If the M28F008 is deselected during block erase or byte write, the device will continue functioning and consuming normal active power until the operation completes.

Deep Power-Down

The M28F008 offers a deep powerdown feature, entered when \overline{RP} is at V_{IL} . Current draw thru V_{CC} is 100 μA maximum in deep powerdown mode, with current draw through V_{PP} 20 μA maximum. During

read modes, \overline{RP} at a logic-low level (V_{IL}) deselects the memory, places output drivers in a high-impedance state and turns off all internal circuits. The M28F008 requires time t_{PHQV} (see AC Characteristics-Read-Only Operations) after return from powerdown until initial memory access outputs are valid. After this wakeup interval, normal operation is restored. The Command User Interface is reset to Read Array mode, and the upper 5 bits of the Status Register are cleared to value 10000, upon return to normal operation.

During block erase or byte write modes, \overline{RP} at a logic-low level (V_{IL}) will abort either operation. Memory contents of the block being altered are no longer valid as the data will be partially written or erased. Time t_{PHWL} after \overline{RP} goes to logic-high (V_{IH}) is required before another command can be written.

Intelligent Identifier Operation

The intelligent identifier operation outputs the manufacturer code, 89H; and the device code, A2H for the M28F008. The system CPU can then automatically match the device with its proper block erase and byte write algorithms.

The manufacturer and device codes are read via the Command User Interface. Following a write of 90H to the Command User Interface, a read from address location 00000H outputs the manufacturer code (89H). A read from address location 00001H outputs the device code (A2H). It is not necessary to have high voltage applied to V_{PP} to read the intelligent identifier from the Command User Interface.

Table 3. Command Definitions

Command	Bus Cycles Req'd	Notes	First Bus Cycle			Second Bus Cycle		
			Operation	Address	Data	Operation	Address	Data
Read Array/Reset	1	1	Write	X	FFH			
Intelligent Identifier	3	2, 3, 4	Write	X	90H	Read	IA	IID
Read Status Register	2	3	Write	X	70H	Read	X	SRD
Clear Status Register	1		Write	X	50H			
Erase Setup/Erase Confirm	2	2	Write	BA	20H	Write	BA	D0H
Erase Suspend/Erase Resume	2		Write	X	B0H	Write	X	D0H
Byte Write Setup/Write	2	2, 3, 5	Write	WA	40H	Write	WA	WD
Alternate Byte Write Setup/Write	2	2, 3, 5	Write	WA	10H	Write	WA	WD

NOTES:

- Bus operations are defined in Table 2.
- IA = Identifier Address: 00H for manufacturer code, 01H for device code.
BA = Address within the block being erased.
WA = Address of memory location to be written.
- SRD = Data read from Status Register. See Table 4 for a description of the Status Register bits.
WD = Data to be written at location WA. Data is latched on the rising edge of \overline{WE} .
IID = Data read from intelligent identifiers.
- Following the intelligent identifier command, two read operations access manufacture and device codes.
- Either 40H or 10H are recognized by the WSM as the Byte Write Setup command.
- Commands other than those shown above are reserved by Intel for future device implementations and should not be used.

Write

Writes to the Command User Interface enable reading of device data and intelligent identifier. They also control inspection and clearing of the Status Register. Additionally, when $V_{PP} = V_{PPH}$, the Command User Interface controls block erasure and byte write. The contents of the interface register serve as input to the internal write state machine.

The Command User Interface itself does not occupy an addressable memory location. The interface register is a latch used to store the command and address and data information needed to execute the command. Erase Setup and Erase Confirm commands require both appropriate command data and an address within the block to be erased. The Byte Write Setup command requires both appropriate command data and the address of the location to be written, while the Byte Write command consists of the data to be written and the address of the location to be written.

The Command User Interface is written by bringing \overline{WE} to a logic-low level (V_{IL}) while \overline{CE} is low. Addresses and data are latched on the rising edge of \overline{WE} . Standard microprocessor write timings are used.

Refer to AC Write Characteristics and the AC Waveforms for Write Operations, Figure 9, for specific timing parameters.

COMMAND DEFINITIONS

When V_{PPL} is applied to the V_{PP} pin, read operations from the Status Register, intelligent identifier, or array blocks are enabled. Placing V_{PPH} on V_{PP} enables successful byte write and block erase operations as well.

Device operations are selected by writing specific commands into the Command User Interface. Table 3 defines the M28F008 commands.

Read Array Command

Upon initial device powerup and after exit from deep powerdown mode, the M28F008 defaults to Read Array mode. This operation is also initiated by writing FFH into the Command User Interface. Microprocessor read cycles retrieve array data. The device remains enabled for reads until the Command User Interface contents are altered. Once the internal Write State Machine has started a block erase or byte write operation, the device will not recognize

Table 4. Status Register Definitions

	WSMS	ESS	ES	BWS	VPPS	R	R	R
	7	6	5	4	3	2	1	0
SR.7 = WRITE STATE MACHINE STATUS								
1 = Ready								
0 = Busy								
SR.6 = ERASE SUSPEND STATUS								
1 = Erase Suspended								
0 = Erase in Progress/Completed								
SR.5 = ERASE STATUS								
1 = Error in Block Erasure								
0 = Successful Block Erase								
SR.4 = BYTE WRITE STATUS								
1 = Error in Byte Write								
0 = Successful Byte Write								
SR.3 = V _{PP} STATUS								
1 = V _{PP} Low Detect; Operation Abort								
0 = V _{PP} OK								
SR.2-SR.0 = RESERVED FOR FUTURE ENHANCEMENTS								
These bits are reserved for future use and should be masked out when polling the Status Register.								

NOTES:

RY/B \bar{Y} or the Write State Machine Status bit must first be checked to determine byte write or block erase completion, before the Byte Write or Erase Status bit are checked for success.

If the Byte Write AND Erase Status bits are set to “1”s during a block erase attempt, an improper command sequence was entered. Attempt the operation again.

If V_{PP} low status is detected, the Status Register must be cleared before another byte write or block erase operation is attempted.

The V_{PP} Status bit, unlike an A/D converter, does not provide continuous indication of V_{PP} level. The WSM interrogates the V_{PP} level only after the byte write or block erase command sequences have been entered and informs the system if V_{PP} has not been switched on. The V_{PP} Status bit is not guaranteed to report accurate feedback between V_{PP}L and V_{PP}H.

the Read Array command, until the WSM has completed its operation. The Read Array command is functional when V_{PP} = V_{PP}L or V_{PP}H.

Intelligent Identifier Command

The M28F008 contains an intelligent identifier operation, initiated by writing 90H into the Command User Interface. Following the command write, a read cycle from address 00000H retrieves the manufacturer code of 89H. A read cycle from address 01H returns the device code of A2H. To terminate the operation, it is necessary to write another valid command into the register. Like the Read Array command, the intelligent identifier command is functional when V_{PP} = V_{PP}L or V_{PP}H.

Read Status Register Command

The M28F008 contains a Status Register which may be read to determine when a byte write or block erase operation is complete, and whether that operation completed successfully. The Status Register may be read at any time by writing the Read Status Register command (70H) to the Command User Interface. After writing this command, all subsequent read operations output data from the Status Register, until another valid command is written to the

Command User Interface. The contents of the Status Register are latched on the falling edge of \bar{OE} or \bar{CE} , whichever occurs last in the read cycle. \bar{OE} or \bar{CE} must be toggled to V_IH before further reads to update the Status Register latch. The Read Status Register command functions when V_{PP} = V_{PP}L or V_{PP}H.

Clear Status Register Command

The Erase Status and Byte Write Status bits are set to “1”s by the Write State Machine and can only be reset by the Clear Status Register Command. These bits indicate various failure conditions (see Table 4). By allowing system software to control the resetting of these bits, several operations may be performed (such as cumulatively writing several bytes or erasing multiple blocks in sequence). The Status Register may then be polled to determine if an error occurred during that sequence. This adds flexibility to the way the device may be used.

Additionally, the V_{PP} Status bit (SR.3) MUST be reset by system software before further byte writes or block erases are attempted. To clear the Status Register, the Clear Status Register command (50H) is written to the Command User Interface. The Clear Status Register command is functional when V_{PP} = V_{PP}L or V_{PP}H.

Erase Setup/Erase Confirm Commands

Erase is executed one block at a time, initiated by a two-cycle command sequence. An Erase Setup command (20H) is first written to the Command User Interface, followed by the Erase Confirm command (D0H). These commands require both appropriate sequencing and an address within the block to be erased to FFH. Block preconditioning, erase and verify are all handled internally by the Write State Machine, invisible to the system. After the two-command erase sequence is written to it, the M28F008 automatically outputs Status Register data when read (see Figure 6; Block Erase Flowchart). The CPU can detect the completion of the erase event by analyzing the output of the RY/B \bar{Y} pin, or the WSM Status bit of the Status Register.

When erase is completed, the Erase Status bit should be checked. If erase error is detected, the Status Register should be cleared. The Command User Interface remains in Read Status Register mode until further commands are issued to it.

This two-step sequence of set-up followed by execution ensures that memory contents are not accidentally erased. Also, reliable block erasure can only occur when $V_{PP} = V_{PPH}$. In the absence of this high voltage, memory contents are protected against erasure. If block erase is attempted while $V_{PP} = V_{PPL}$, the V_{PP} Status bit will be set to "1". Erase attempts while $V_{PPL} < V_{PP} < V_{PPH}$ produce spurious results and should not be attempted.

Erase Suspend/Erase Resume Commands

The Erase Suspend command allows block erase interruption in order to read data from another block of memory. Once the erase process starts, writing the Erase Suspend command (B0H) to the Command User Interface requests that the WSM suspend the erase sequence at a predetermined point in the erase algorithm. The M28F008 continues to output Status Register data when read, after the Erase Suspend command is written to it. Polling the WSM status and Erase Suspend status bits will determine when the erase operation has been suspended (both will be set to "1"). RY/B \bar{Y} will also transition to V_{OH} .

At this point, a Read Array command can be written to the Command User Interface to read data from blocks other than that which is suspended. The only other valid commands at this time are Read Status Register (70H) and Erase Resume (D0H), at which time the WSM will continue with the erase process. The Erase Suspend status and WSM status bits of the Status Register will be automatically cleared and RY/B \bar{Y} will return to V_{OL} . After the Erase Resume command is written to it, the M28F008 automatically outputs Status Register data when read (see Figure 7; Erase Suspend/Resume Flowchart). V_{PP} must remain at V_{PPH} while the M28F008 is in Erase Suspend.

Byte Write Setup/Write Commands

Byte write is executed by a two-command sequence. The Byte Write Setup command (40H) is written to the Command User Interface, followed by a second write specifying the address and data (latched on the rising edge of \overline{WE}) to be written. The WSM then takes over, controlling the byte write and write verify algorithms internally. After the two-command byte write sequence is written to it, the M28F008 automatically outputs Status Register data when read (see Figure 5; Byte Write Flowchart). The CPU can detect the completion of the byte write event by analyzing the output of the RY/B \bar{Y} pin, or the WSM status bit of the Status Register. Only the Read Status Register command is valid while byte write is active.

When byte write is complete, the Byte Write status bit should be checked. If byte write error is detected, the Status Register should be cleared. The internal WSM verify only detects errors for "1"s that do not successfully write to "0"s. The Command User Interface remains in Read Status Register mode until further commands are issued to it. If byte write is attempted while $V_{PP} = V_{PPL}$, the V_{PP} Status bit will be set to "1". Byte write attempts while $V_{PPL} < V_{PP} < V_{PPH}$ produce spurious results and should not be attempted.

EXTENDED BLOCK ERASE/BYTE WRITE CYCLING

Intel has designed extended cycling capability into its ETOX flash memory technologies. The M28F008 is designed for 10,000 byte write/block erase cycles on each of the sixteen 64 Kbyte blocks. Low electric fields, advanced oxides and minimal oxide area per cell subjected to the tunneling electric field combine to greatly reduce oxide stress and the probability of failure. A 20 Mbyte solid-state drive using an array of M28F008s has a MTBF (Mean Time Between Failure) of 3.33 million hours⁽¹⁾, over 600 times more reliable than equivalent rotating disk technology.

AUTOMATED BYTE WRITE

The M28F008 integrates the Quick-Pulse programming algorithm of prior Intel Flash devices on-chip, using the Command User Interface, Status Register and Write State Machine (WSM). On-chip integration dramatically simplifies system software and provides processor interface timings to the Command User Interface and Status Register. WSM operation, internal verify and V_{PP} high voltage presence are monitored and reported via the RY/BY output and appropriate Status Register bits. Figure 5 shows a system software flowchart for device byte write. The entire sequence is performed with V_{PP} at V_{PPH} . Byte write abort occurs when \overline{RP} transitions to V_{IL} or V_{PP} drops to V_{PPL} . Although the WSM is halted, byte data is partially written at the location where byte write was aborted. Block erasure, or a repeat of byte write, is required to initialize this data to a known value.

AUTOMATED BLOCK ERASE

As above, the Quick-Erase algorithm of prior Intel Flash devices is now implemented internally, including all preconditioning of block data. WSM operation, erase success and V_{PP} high voltage presence are monitored and reported through RY/BY and the Status Register. Additionally, if a command other than Erase Confirm is written to the device following Erase Setup, both the Erase Status and Byte Write Status bits will be set to "1"s. When issuing the Erase Setup and Erase Confirm commands, they should be written to an address within the address range of the block to be erased. Figure 6 shows a system software flowchart for block erase.

Erase typically takes 1.6 seconds per block. The Erase Suspend/Erase Resume command sequence allows suspension of this erase operation to read data from a block other than that in which erase is being performed. A system software flowchart is shown in Figure 7.

The entire sequence is performed with V_{PP} at V_{PPH} . Abort occurs when \overline{RP} transitions to V_{IL} or V_{PP} falls to V_{PPL} , while erase is in progress. Block data is partially erased by this operation, and a repeat of erase is required to obtain a fully erased block.

DESIGN CONSIDERATIONS

Three-Line Output Control

The M28F008 will often be used in large memory arrays. Intel provides three control inputs to accommodate multiple memory connections. Three-line control provides for:

- lowest possible memory power dissipation
- complete assurance that data bus contention will not occur

To efficiently use these control inputs, an address decoder should enable \overline{CE} , while \overline{OE} should be connected to all memory devices and the system's \overline{READ} control line. This assures that only selected memory devices have active outputs while deselected memory devices are in Standby Mode. Finally, \overline{RP} should either be tied to the system RESET, or connected to V_{CC} if unused.

RY/ \overline{BY} and Byte Write/Block Erase Polling

RY/ \overline{BY} is a full CMOS output that provides a hardware method of detecting byte write and block erase completion. It transitions low time t_{WHRL} after a write or erase command sequence is written to the M28F008, and returns to V_{OH} when the WSM has finished executing the internal algorithm.

RY/ \overline{BY} can be connected to the interrupt input of the system CPU or controller. It is active at all times, not tri-stated if the M28F008 \overline{CE} or \overline{OE} inputs are brought to V_{IH} . RY/ \overline{BY} is also V_{OH} when the device is in Erase Suspend or deep powerdown modes.

⁽¹⁾Assumptions: 10 Kbyte file written every 10 minutes. (20 Mbyte array)/(10 Kbyte file) = 2,000 file writes before erase required.
 (2000 files writes/erase) × (10,000 cycles per M28F008 block) = 20 million file writes.
 (20 × 10⁶ file writes) × (10 min/write) × (1 hr/60 min) = **3.33 × 10⁶ MTBF.**

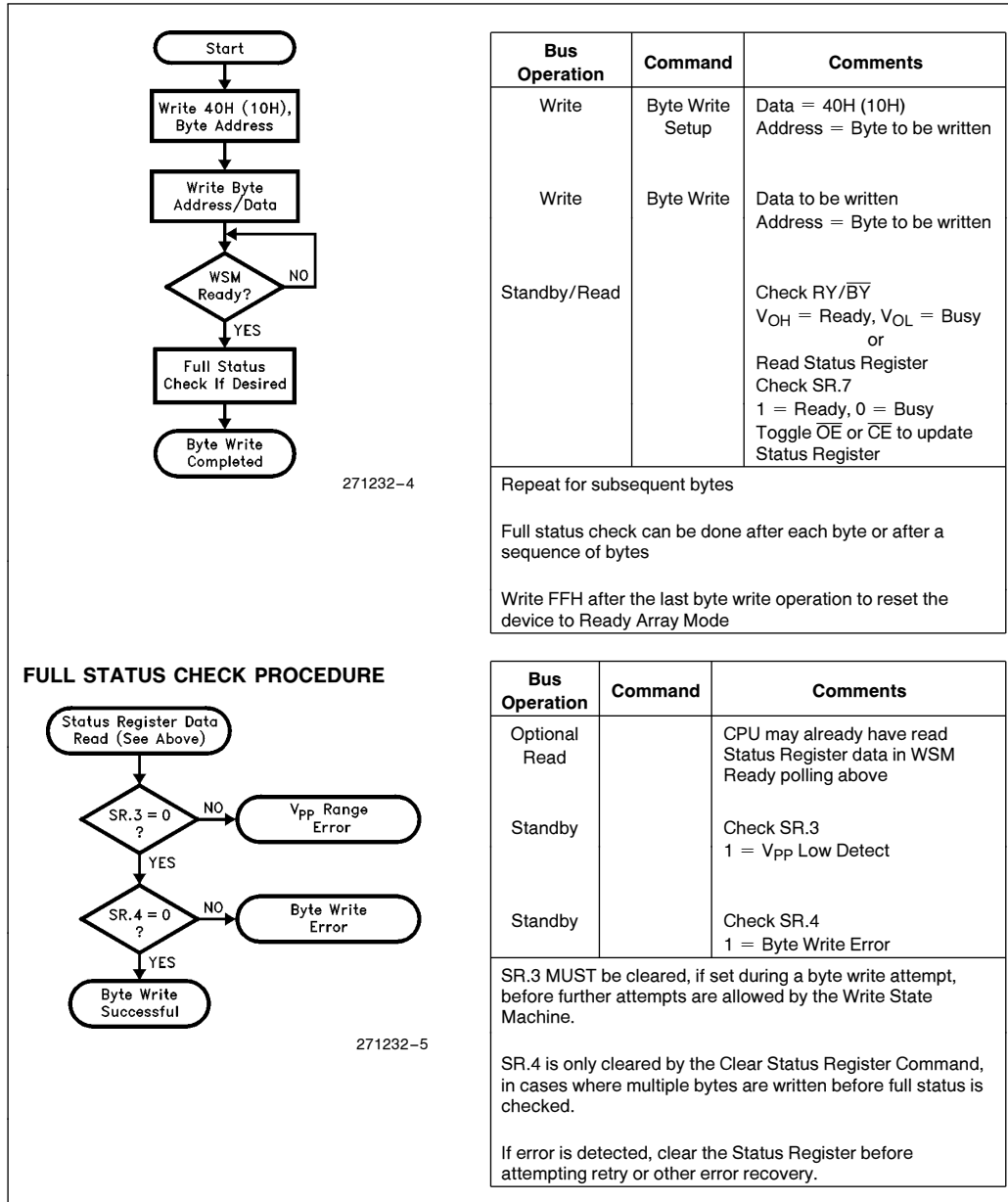

Figure 5. Automated Byte Write Flowchart

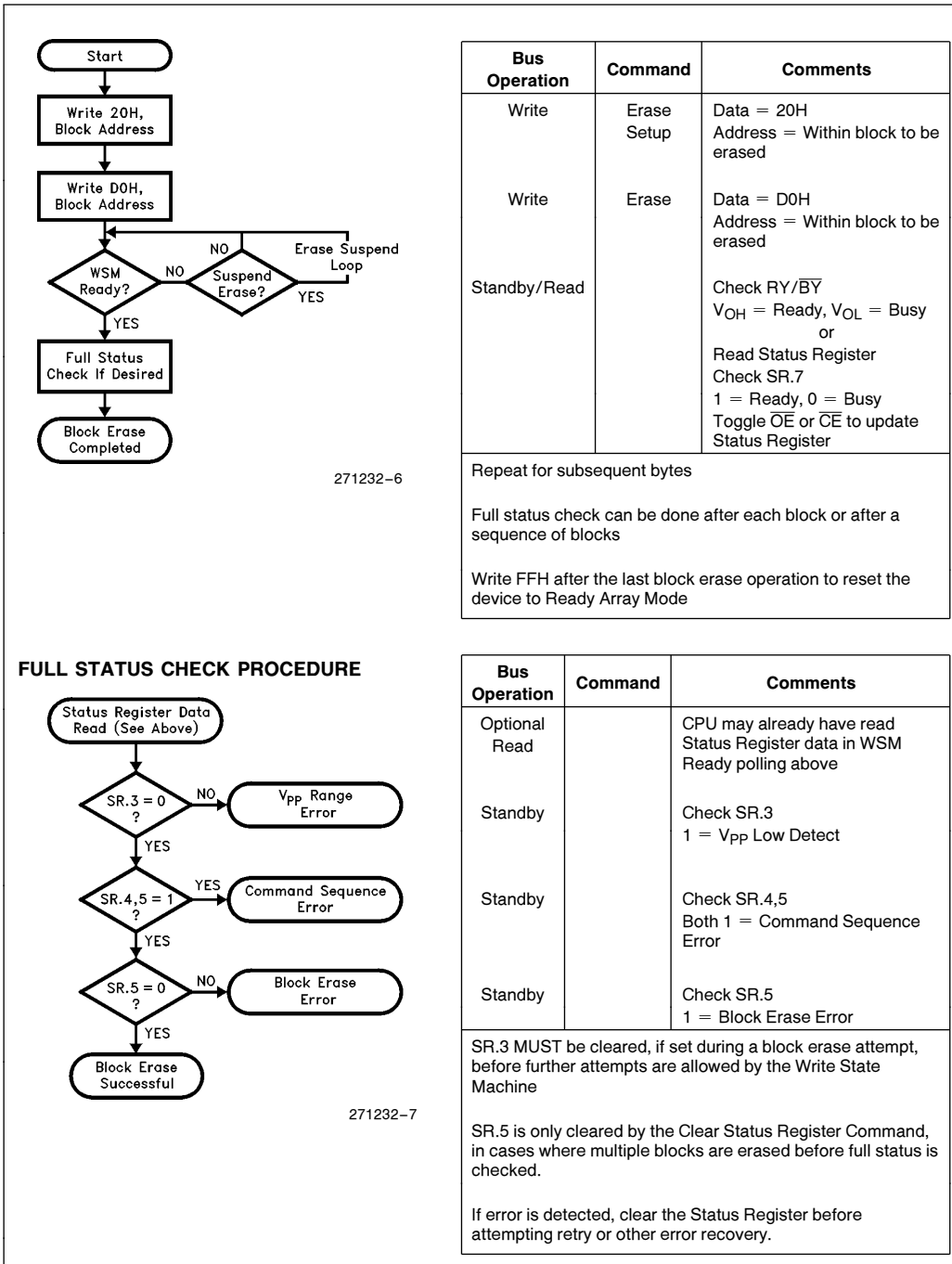

Figure 6. Automated Block Erase Flowchart

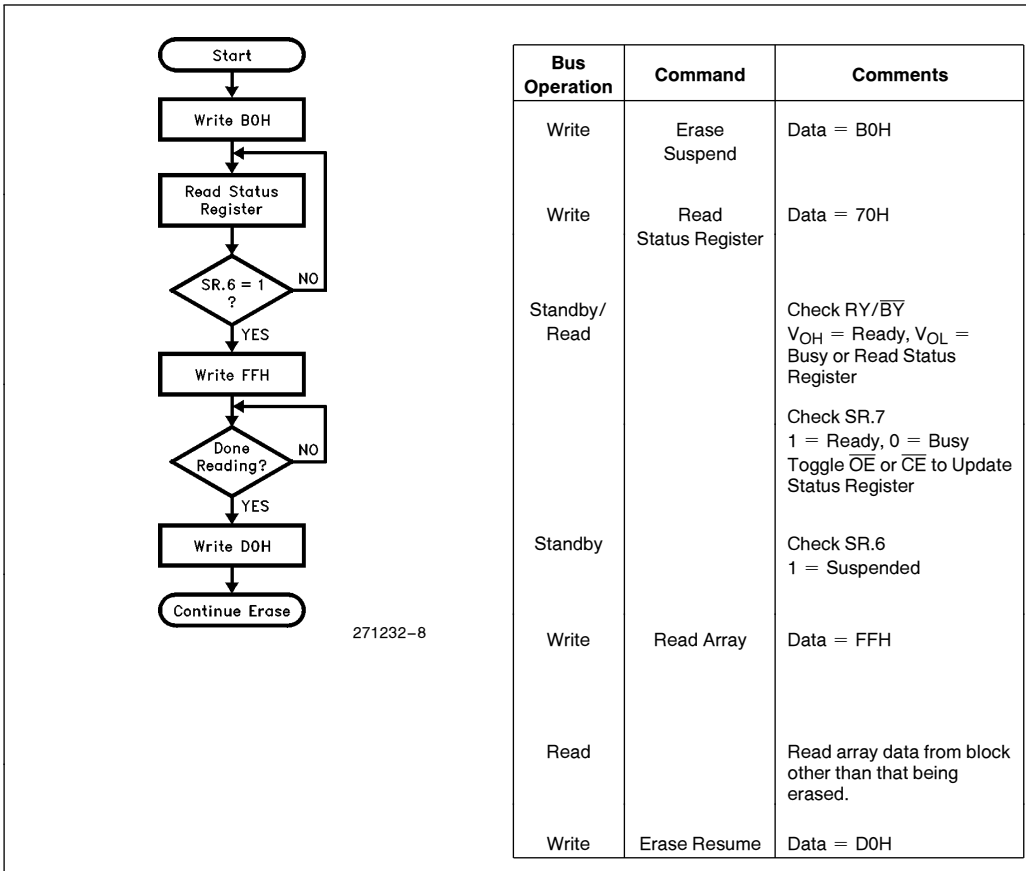

Figure 7. Erase Suspend/Resume Flowchart

Power Supply Decoupling

Flash memory power switching characteristics require careful device decoupling. System designers are interested in 3 supply current issues; standby current levels (I_{SB}), active current levels (I_{CC}) and transient peaks produced by falling and rising edges of \overline{CE} . Transient current magnitudes depend on the device outputs' capacitive and inductive loading. Two-line control and proper decoupling capacitor selection will suppress transient voltage peaks. Each device should have a 0.1 μ F ceramic capacitor connected between each V_{CC} and GND, and between its V_{PP} and GND. These high frequency, low inherent-inductance capacitors should be placed as close as possible to package leads. Additionally, for every 8 devices, a 4.7 μ F electrolytic capacitor should be placed at the array's power supply connection between V_{CC} and GND. The bulk capacitor will overcome voltage slumps caused by PC board trace inductances.

V_{PP} Trace on Printed Circuit Boards

Writing flash memories, while they reside in the target system, requires that the printed circuit board designer pay attention to the V_{PP} power supply trace. The V_{PP} pin supplies the memory cell current for writing and erasing. Use similar trace widths and layout considerations given to the V_{CC} power bus. Adequate V_{PP} supply traces and decoupling will decrease V_{PP} voltage spikes and overshoots.

V_{CC} , V_{PP} , \overline{RP} Transitions and the Command/Status Registers

Byte write and block erase completion are not guaranteed if V_{PP} drops below V_{PPH} . If the V_{PP} Status bit of the Status Register (SR.3) is set to "1", a Clear Status Register command MUST be issued before further byte write/block erase attempts are allowed by the WSM. Otherwise, the Byte Write (SR.4) or Erase (SR.5) Status bits of the Status Register will be set to "1"s if error is detected. \overline{RP} transitions to V_{IL} during byte write and block erase also abort the operations. Data is partially altered in either case, and the command sequence must be repeated after normal operation is restored. Device poweroff, or \overline{RP} transitions to V_{IL} , clear the Status Register to initial value 10000 for the upper 5 bits.

The Command User Interface latches commands as issued by system software and is not altered by V_{PP} or \overline{CE} transitions or WSM actions. Its state upon powerup, after exit from deep powerdown or after V_{CC} transitions below V_{LKO} , is Read Array Mode.

After byte write or block erase is complete, even after V_{PP} transitions down to V_{PPL} , the Command User Interface must be reset to Read Array mode via the Read Array command if access to the memory array is desired.

Power Up/Down Protection

The M28F008 is designed to offer protection against accidental block erasure or byte writing during power transitions. Upon power-up, the M28F008 is indifferent as to which power supply, V_{PP} or V_{CC} , powers up first. Power supply sequencing is not required. Internal circuitry in the M28F008 ensures that the Command User Interface is reset to the Read Array mode on power up.

A system designer must guard against spurious writes for V_{CC} voltages above V_{LKO} when V_{PP} is active. Since both \overline{WE} and \overline{CE} must be low for a command write, driving either to V_{IH} will inhibit writes. The Command User Interface architecture provides an added level of protection since alteration of memory contents only occurs after successful completion of the two-step command sequences.

Finally, the device is disabled until \overline{RP} is brought to V_{IH} , regardless of the state of its control inputs. This provides an additional level of memory protection.

Power Dissipation

When designing portable systems, designers must consider battery power consumption not only during device operation, but also for data retention during system idle time. Flash nonvolatility increases usable battery life, because the M28F008 does not consume any power to retain code or data when the system is off.

In addition, the M28F008's deep powerdown mode ensures low power dissipation even when system power is applied. For example, portable PCs and other power sensitive applications, using an array of M28F008s for solid-state storage, can lower \overline{RP} to V_{IL} in standby or sleep modes, reducing power consumption. If access to the M28F008 is again needed, the part can again be read, following the t_{PHQV} and t_{PHWL} wakeup cycles required after \overline{RP} is first raised back to V_{IH} . See AC Characteristics—Read-Only and Write Operations and Figures 8 and 9 for more information.

ABSOLUTE MAXIMUM RATINGS*

Operating Temperature	−55°C to +125°C
Temperature Under Bias	−55°C to +125°C
Storage Temperature	−65°C to +125°C
Voltage on Any Pin (except V _{CC} and V _{PP}) with Respect to GND	−2.0V to +7.0V(1)
V _{PP} Program Voltage with Respect to GND during Block Erase/Byte Write	−2.0V to +14.0V(1,2)
V _{CC} Supply Voltage with Respect to GND	−2.0V to +7.0V(1)
Output Short Circuit Current	100 mA(3)

NOTICE: This data sheet contains preliminary information on new products in production. The specifications are subject to change without notice. Verify with your local Intel Sales office that you have the latest data sheet before finalizing a design.

*WARNING: Stressing the device beyond the "Absolute Maximum Ratings" may cause permanent damage. These are stress ratings only. Operation beyond the "Operating Conditions" is not recommended and extended exposure beyond the "Operating Conditions" may affect device reliability.

NOTES:

1. Minimum DC voltage is −0.5V on input/output pins. During transitions, this level may undershoot to −2.0V for periods <20 ns. Maximum DC voltage on input/output pins is V_{CC} + 0.5V which, during transitions, may overshoot to V_{CC} + 2.0V for periods <20 ns.
2. Maximum DC voltage on V_{PP} may overshoot to +14.0V for periods <20 ns.
3. Output shorted for no more than one second. No more than one output shorted at a time.

OPERATING CONDITIONS

Symbol	Parameter	Min	Max	Unit
T _C	Operating Temperature	−55	+125	°C
V _{CC}	V _{CC} Supply Voltage (10%)	4.50	5.50	V

DC CHARACTERISTICS

Symbol	Parameter	Notes	MC28F008 and MF28F008		Unit	Test Conditions
			Min	Max		
I _{LI}	Input Load Current	1		±1.0	μA	V _{CC} = V _{CC} Max V _{IN} = V _{CC} or GND
I _{LO}	Output Load Current	1		±10	μA	V _{CC} = V _{CC} Max V _{OUT} = V _{CC} or GND
I _{CCS}	V _{CC} Standby Current	1, 3		2.0	mA	V _{CC} = V _{CC} Max CE = RP = V _{IH}
				150	μA	V _{CC} = V _{CC} Max CE = RP = V _{CC} ±0.2V
I _{CCD}	V _{CC} Deep Powerdown Current	1		100	μA	RP = GND ±0.2V I _{OUT} (RY/BY) = 0 mA
I _{CCR}	V _{CC} Read Current	1		35	mA	V _{CC} = V _{CC} Max, CE = GND, F = 8 MHz, I _{OUT} = 0 mA, CMOS Inputs
				50	mA	V _{CC} = V _{CC} Max, CE = V _{IL} , F = 8 MHz, I _{OUT} = 0 mA, TTL Inputs

DC CHARACTERISTICS (Continued)

Symbol	Parameter	Notes	MC28F008 and MF28F008		Unit	Test Conditions
			Min	Max		
I _{CCW}	V _{CC} Byte Write Current	1		30	mA	Byte Write In Progress
I _{CCE}	V _{CC} Block Erase Current	1		30	mA	Block Erase In Progress
I _{CCES}	V _{CC} Erase Suspend Current	1, 2		10	mA	Block Erase Suspended $\overline{CE} = V_{IH}$
I _{PPS}	V _{PP} Standby Current	1		± 15	μA	V _{PP} ≤ V _{CC}
				200	μA	V _{PP} > V _{CC}
I _{PPD}	V _{PP} Deep PowerDown Current	1		20	μA	$\overline{RP} = GND \pm 0.2V$
I _{PPW}	V _{PP} Write Current	1		30	mA	V _{PP} = V _{PPH} Byte Write in Progress
I _{PPE}	V _{PP} Block Erase Current	1		30	mA	V _{PP} = V _{PPH} Block Erase in Progress
I _{PPES}	V _{PP} Erase Suspend Current	1		200	μA	V _{PP} = V _{PPH} Block Erase Suspended
V _{IL}	Input Low Voltage		-0.5	0.8	V	
V _{IH}	Input High Voltage		2.0	V _{CC} + 0.5	V	
V _{OL}	Output Low Voltage	3		0.45	V	V _{CC} = V _{CC} Min I _{OL} = 5.8 mA
V _{OH}	Output High Voltage	3	2.4		V	V _{CC} = V _{CC} Min I _{OH} = -2.5 mA
V _{PPL}	V _{PP} during Normal Operations	4	0.0	6.5	V	
V _{PPH}	V _{PP} during Erase/Write Operations		11.4	12.6	V	
V _{LKO}	V _{CC} Erase/Write Lock Voltage		1.8		V	

CAPACITANCE⁽⁵⁾ T_A = 25°C, f = 1 MHz

Symbol	Parameter	Typ	Max	Unit	Condition
C _{IN}	Input Capacitance	6	8	pF	V _{IN} = 0V
C _{OUT}	Output Capacitance	8	12	pF	V _{OUT} = 0V

NOTES:

- All currents are in RMS unless otherwise noted.
- I_{CCES} is specified with the device deselected. If the M28F008 is read while in Erase Suspend Mode, current draw is the sum of I_{CCES} and I_{CCR}.
- Includes RY/BY.
- Block Erases/Byte Writes are inhibited when V_{PP} = V_{PPL} and not guaranteed in the range between V_{PPH} and V_{PPL}.

AC INPUT/OUTPUT REFERENCE WAVEFORM

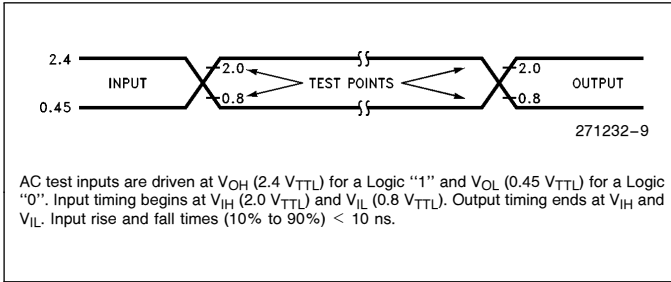

AC TESTING LOAD CIRCUIT

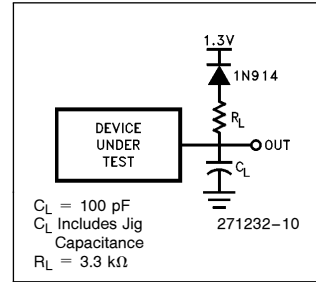

AC CHARACTERISTICS—Read-Only Operations(1, 4)

Symbol		Parameter	Notes	M28F008-10(4)		M28F008-12(4)		Unit
				Min	Max	Min	Max	
t_{AVAV}	t_{RC}	Read Cycle Time		100		120		ns
t_{AVQV}	t_{ACC}	Address to Output Delay			100		120	ns
t_{ELQV}	t_{CE}	\overline{CE} to Output Delay	2		100		120	ns
t_{PHQV}	t_{PWH}	\overline{RP} High to Output Delay			400		400	ns
t_{GLQV}	t_{OE}	\overline{OE} to Output Delay	2		60		60	ns
t_{ELQX}	t_{LZ}	\overline{CE} to Output Low Z	3	0		0		ns
t_{EHQZ}	t_{HZ}	\overline{CE} High to Output High Z	3		55		55	ns
t_{GLQX}	t_{OLZ}	\overline{OE} to Output Low Z	3	0		0		ns
t_{GHQZ}	t_{DF}	\overline{OE} High to Output High Z	3		30		30	ns
	t_{OH}	Output Hold from Addresses, \overline{CE} or \overline{OE} Change, Whichever is First	3	0		0		ns

NOTES:

- See AC Input/Output Reference Waveform for timing measurements.
- \overline{OE} may be delayed up to $t_{CE} - t_{OE}$ after the falling edge of \overline{CE} without impact on t_{CE} .
- Sampled, not 100% tested.
- See AC Input/Output Reference Waveforms and AC Testing Load Circuits for testing characteristics.

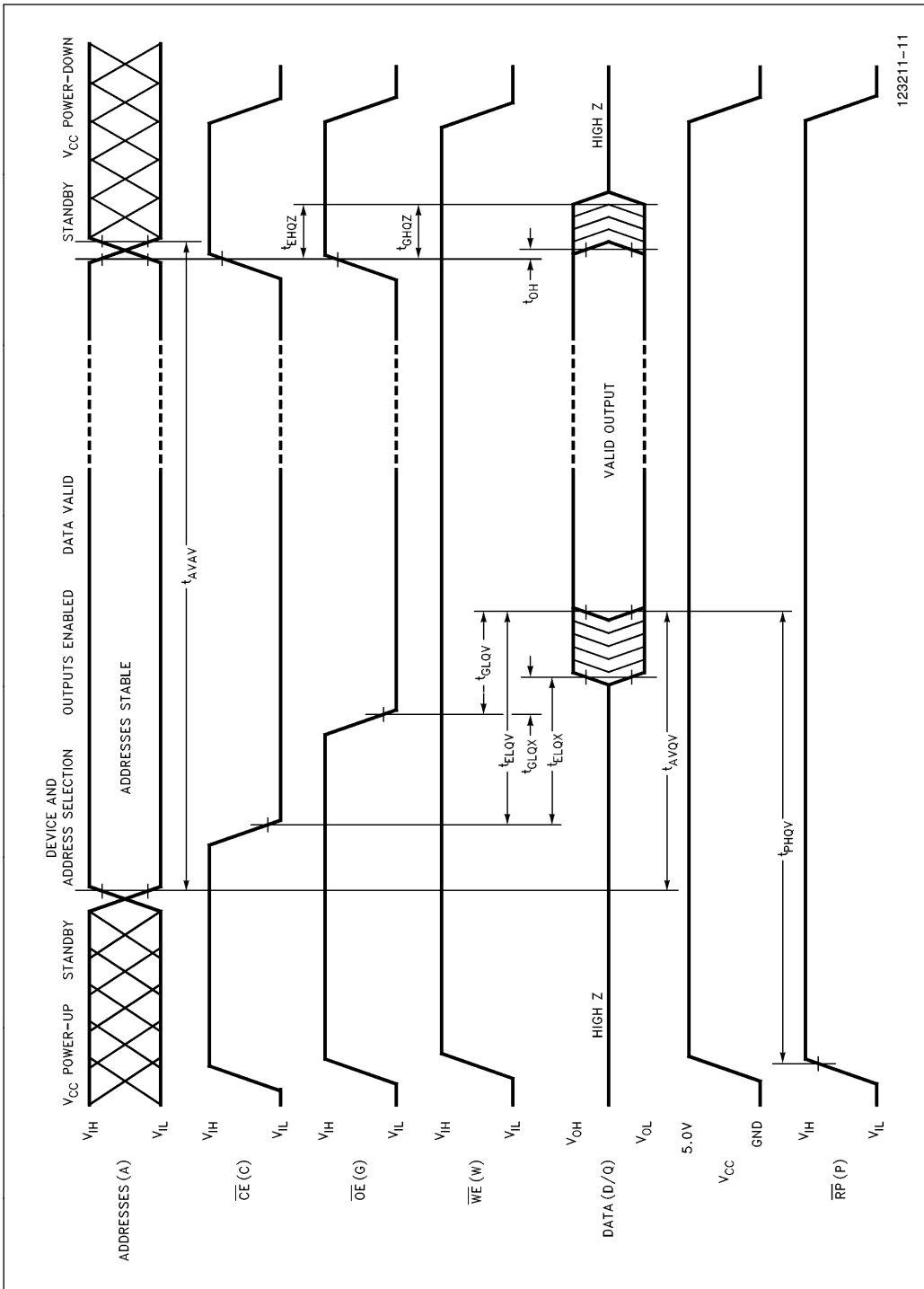

Figure 8. AC Waveform for Read Operations

AC CHARACTERISTICS—Write Operations(1, 7)

Symbol		Parameter	Notes	M28F008-10(7)		M28F008-12(7)		Unit
				Min	Max	Min	Max	
t _{AVAV}	t _{WC}	Write Cycle Time		100		120		ns
t _{PHWL}	t _{PS}	\overline{RP} High Recovery to \overline{WE} Going Low	2	1		1		μ s
t _{ELWL}	t _{CS}	\overline{CE} Setup to \overline{WE} Going Low		10		10		ns
t _{WLWH}	t _{WP}	\overline{WE} Pulse Width		40		40		ns
t _{VPWH}	t _{VPS}	V _{PP} Setup to \overline{WE} Going High	2	100		100		ns
t _{AVWH}	t _{AS}	Address Setup to \overline{WE} Going High	3	40		40		ns
t _{DVWH}	t _{DS}	Data Setup to \overline{WE} Going High	4	40		40		ns
t _{WHDX}	t _{DH}	Data Hold from \overline{WE} High		5		5		ns
t _{WHAX}	t _{AH}	Address Hold from \overline{WE} High		5		5		ns
t _{WHEH}	t _{CH}	\overline{CE} Hold from \overline{WE} High		10		10		ns
t _{WHWL}	t _{WPH}	\overline{WE} Pulse Width High		30		30		ns
t _{WHRL}		\overline{WE} High to RY/ \overline{BY} Going Low			100		100	ns
t _{WHQV1}		Duration of Byte Write Operation	5, 6	6		6		μ s
t _{WHQV2}		Duration of Block Erase Operation	5, 6	0.3		0.3		sec
t _{WHGL}		Write Recovery before Read		0		0		μ s
t _{QVVL}	t _{VPH}	V _{PP} Hold from Valid SRD, RY/ \overline{BY} High	2, 6	0		0		ns

NOTES:

1. Read timing characteristics during erase and byte write operations are the same as during read-only operations. Refer to AC Characteristics for Read-Only Operations.
2. Sampled, not 100% tested.
3. Refer to Table 3 for valid A_{IN} for byte write or block erasure.
4. Refer to Table 3 for valid D_{IN} for byte write or block erasure.
5. The on-chip Write State Machine incorporates all byte write and block erase system functions and overhead of standard Intel flash memory, including byte program and verify (byte write) and block precondition, precondition verify, erase and erase verify (block erase).
6. Byte write and block erase durations are measured to completion (SR.7 = 1, RY/ \overline{BY} = V_{OH}). V_{PP} should be held at V_{PPH} until determination of byte write/block erase success (SR.3/4/5 = 0)
7. See AC Input/Output Reference Waveforms and AC Testing Load Circuits for testing characteristics.

BLOCK ERASE AND BYTE WRITE PERFORMANCE

Parameter	Notes	M28F008-10			M28F008-12			Unit
		Min	Typ	Max	Min	Typ	Max	
Block Erase Time	1, 2		1.6	10		1.6	10	sec
Block Write Time	1, 2		0.6	2.1		0.6	2.1	sec

NOTES:

1. 25°C, 12.0 V_{pp}.
2. Excludes System-Level Overhead.

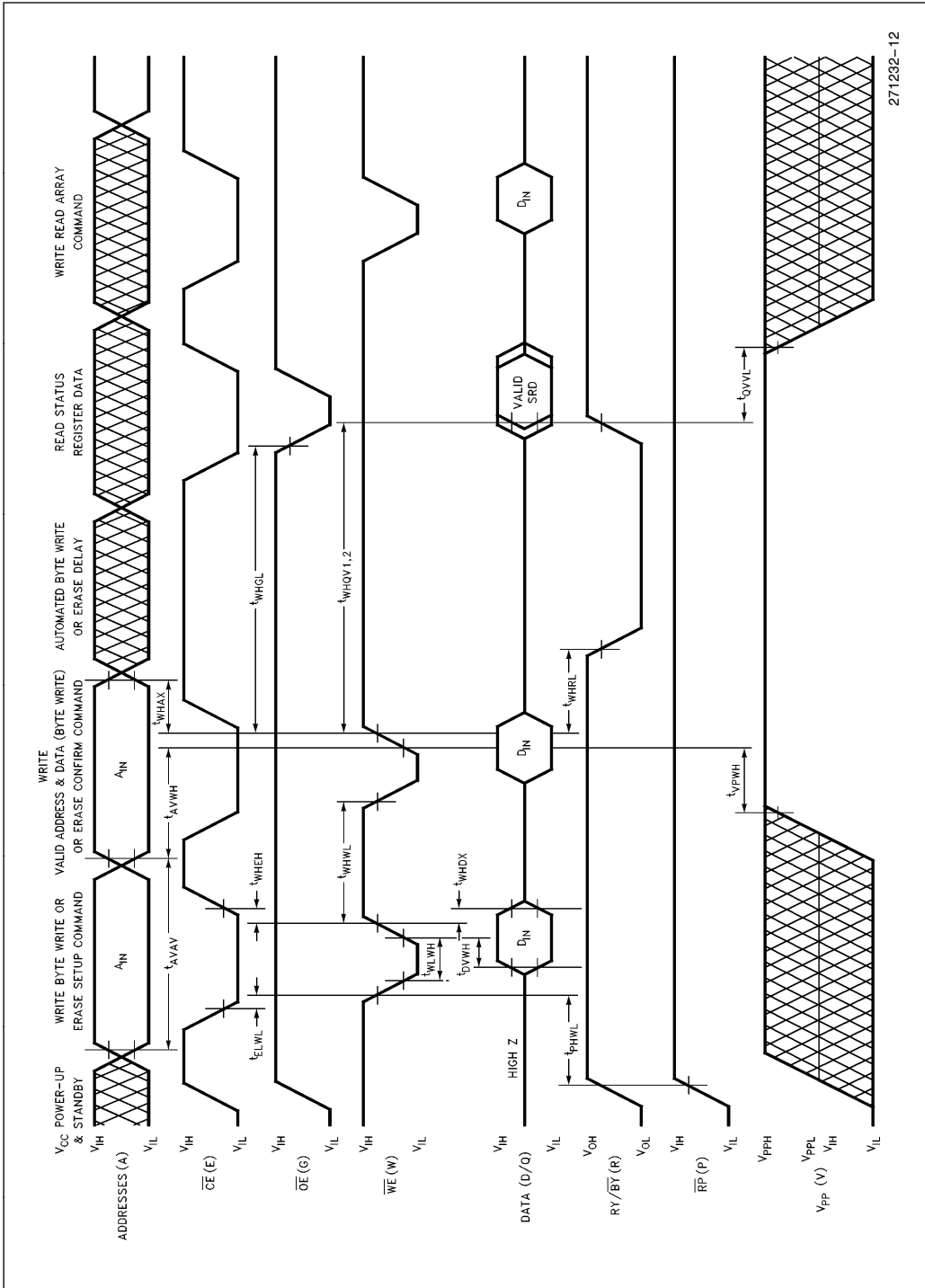

Figure 9. AC Waveform for Write Operations

ALTERNATIVE $\overline{\text{CE}}$ -CONTROLLED WRITES⁽¹⁾

Symbol		Parameter	Notes	M28F008-10 ⁽⁶⁾		M28F008-12 ⁽⁶⁾		Unit
				Min	Max	Min	Max	
t_{AVAV}	t_{WC}	Write Cycle Time		100		120		ns
t_{PHEL}	t_{PS}	$\overline{\text{RP}}$ High Recovery to $\overline{\text{CE}}$ Going Low	2	1		1		μs
t_{WLEL}	t_{WS}	$\overline{\text{WE}}$ Setup to $\overline{\text{CE}}$ Going Low		0		0		ns
t_{LELH}	t_{CP}	$\overline{\text{CE}}$ Pulse Width		50		50		ns
t_{VPEH}	t_{VPS}	V_{PP} Setup to $\overline{\text{CE}}$ Going High	2	100		100		ns
t_{AVEH}	t_{AS}	Address Setup to $\overline{\text{CE}}$ Going High	3	40		40		ns
t_{DVEH}	t_{DS}	Data Setup to $\overline{\text{CE}}$ Going High	4	40		40		ns
t_{EHDX}	t_{DH}	Data Hold from $\overline{\text{CE}}$ High		5		5		ns
t_{EHAX}	t_{AH}	Address Hold from $\overline{\text{CE}}$ High		5		5		ns
t_{EHWL}	t_{WH}	$\overline{\text{WE}}$ Hold from $\overline{\text{CE}}$ High		0		0		ns
t_{EHEL}	t_{EPH}	$\overline{\text{CE}}$ Pulse Width High		25		25		ns
t_{EHRL}		$\overline{\text{CE}}$ High to $\text{RY}/\overline{\text{BY}}$ Going Low			100		100	ns
t_{EHQV1}		Duration of Byte Write Operation	5	6		6		μs
t_{EHQV2}		Duration of Block Erase Operation	5	0.3		0.3		sec
t_{EHGL}		Write Recovery before Read		0		0		μs
t_{QVVL}	t_{VPH}	V_{PP} Hold from Valid SRD, $\text{RY}/\overline{\text{BY}}$ High	2, 5	0		0		ns

NOTES:

1. Chip-Enable Controlled Writes: Write operations are driven by the valid combination of $\overline{\text{CE}}$ and $\overline{\text{WE}}$. In systems where $\overline{\text{CE}}$ defines the write pulsewidth (within a longer $\overline{\text{WE}}$ timing waveform), all setup, hold and inactive $\overline{\text{WE}}$ times should be measured relative to the $\overline{\text{CE}}$ waveform.
2. Sampled, not 100% tested.
3. Refer to Table 3 for valid A_{IN} for byte write or block erasure.
4. Refer to Table 3 for valid D_{IN} for byte write or block erasure.
5. Byte write and block erase durations are measured to completion ($\text{SR}.7 = 1$, $\text{RY}/\overline{\text{BY}} = V_{\text{OH}}$). V_{PP} should be held at V_{PPH} until determination of byte write/block erase success ($\text{SR}.3/4/5 = 0$)
6. See AC Input/Output Reference Waveforms and AC Testing Load Circuits for testing characteristics.

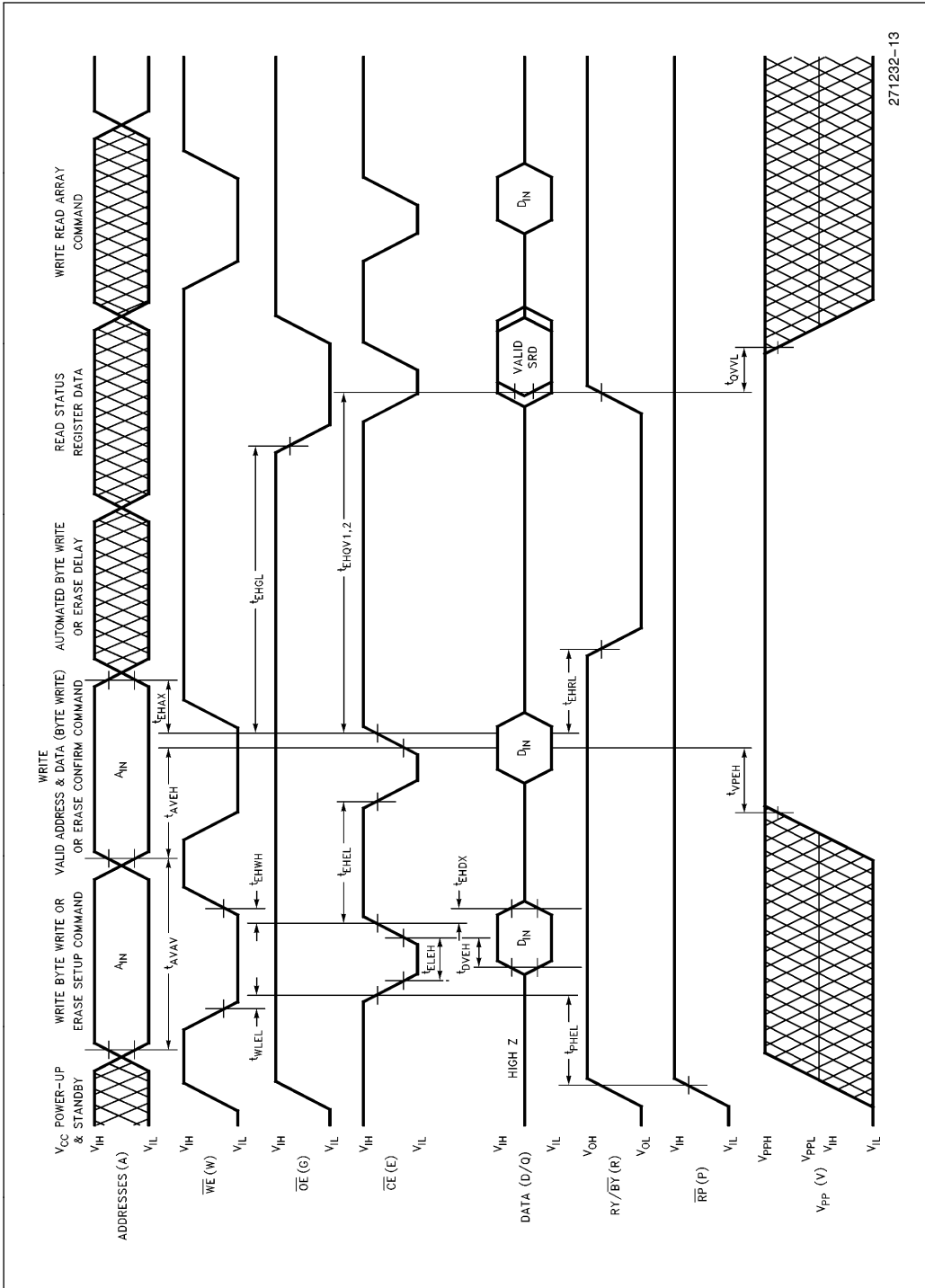

271232-13

Figure 10. Alternate AC Waveform for Write Operations



ORDERING INFORMATION

M	C	2	8	F	0	0	8	-	1	0
---	---	---	---	---	---	---	---	---	---	---

Package	Access Time
C = 40-Pin Sidebrazed DIP	10 = 100 ns
F = 42-Lead Flatpack	12 = 120 ns

ADDITIONAL INFORMATION

		Order Number
	28F008SA-L Data Sheet	290435
AP-359	“28F008SA Hardware Interfacing”	292094
AP-360	“28F008SA Software Drivers”	292095
AP-364	“28F008SA Automation and Algorithms”	292099
ER-27	“The Intel 28F008SA Flash Memory”	294011
ER-28	“ETOX III Flash Memory Technology”	290412

MC28F008 PACKAGE DIMENSIONS

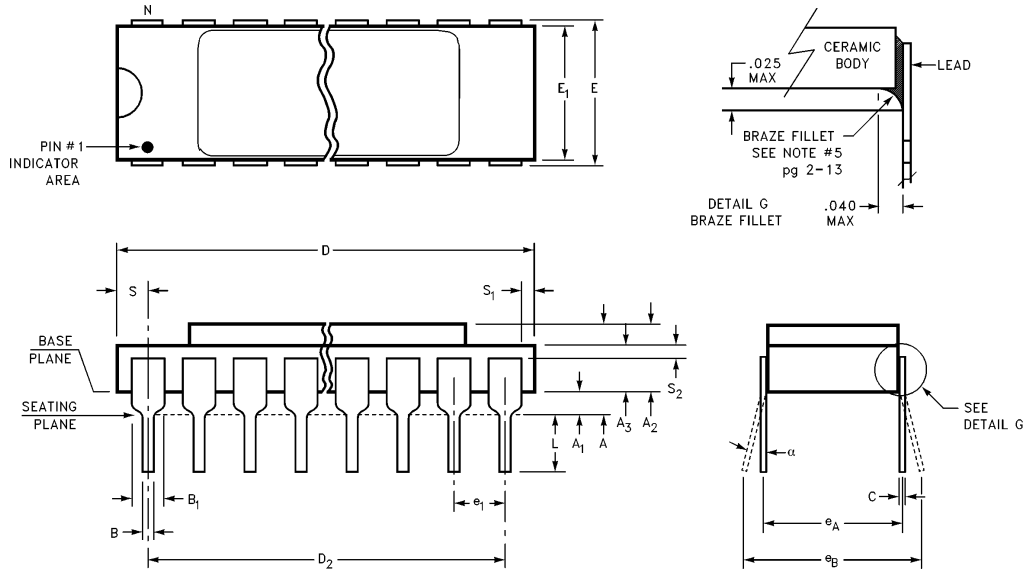

Symbol	Millimeters			Inches		
	Min	Max	Notes	Min	Max	Notes
α	0°	10°		0°	10°	
A	3.30	5.51	Solid Lid	0.130	0.217	Solid Lid
A ₁	1.02	1.52		0.040	0.060	
A ₂	2.29	3.99	Solid Lid	0.090	0.157	Solid Lid
A ₃	2.03	3.66		0.080	0.144	
B	0.38	0.56		0.015	0.022	
B ₁	1.27		Typical	0.050		Typical
C	0.23	0.30	Typical	0.009	0.012	Typical
D	50.29	51.31		1.980	2.020	
D ₂	48.26		Reference	1.900		Reference
E	15.24	15.75		0.600	0.620	
E ₁	14.86	15.37		0.585	0.605	
e ₁	2.29	2.79		0.090	0.110	
e _A	14.99		Reference	0.590		Reference
e _B	15.24	17.15		0.600	0.675	
L	3.18	4.06		0.125	0.160	
N	40			40		
S	0.76	1.78		0.030	0.070	
S ₁	0.13			0.005		
S ₂	0.13			0.005		
ISSUE	IWS					

MF28F008 PACKAGE DIMENSIONS

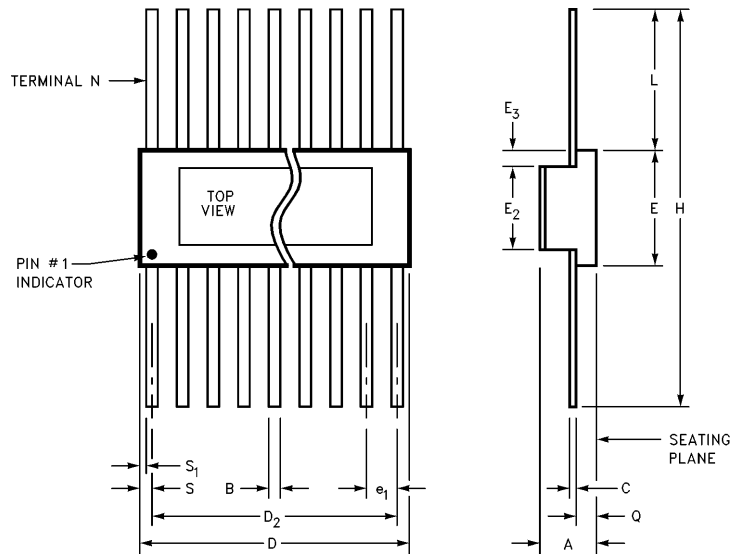

271232-16

Symbol	Millimeters			Inches		
	Min	Max	Notes	Min	Max	Notes
A	2.08	2.17	Solid Lid	0.082	0.103	Solid Lid
B	0.43	0.58	Typical	0.017	0.023	Typical
C	0.13	0.25	Typical	0.005	0.010	Typical
D	26.67	27.18		1.050	1.070	
D_2	25.40		Reference	1.000		Reference
E	16.00	16.51		0.630	0.650	
E_2	13.46	13.97		0.530	0.550	
E_3	0.89	1.65		0.035	0.065	
e_1	1.14	1.40	Typical	0.045	0.055	Typical
H	32.77		Reference	1.29		Reference
L	7.87	8.64		0.310	0.340	
N	42			42		
Q	1.27	1.55		0.050	0.061	
S	0.23	1.02		0.009	0.040	
S_1	0.00	1.27		0.000	0.050	
ISSUE	IWS 8/90					



REVISION HISTORY

Number	Description	Number	Description
-002	<ul style="list-style-type: none"> — Revised Extended Cycling Capability to 10K Block Erase Cycles 160K Block Erase Cycles per Chip — Changed I_{PPS} Standby current spec from $\pm 10 \mu A$ to $\pm 15 \mu A$ — Removed typical Block Erase times 	-003	<ul style="list-style-type: none"> — \overline{PWD} renamed \overline{RP} for JEDEC standardization compatibility — Added MF, 42-Lead Flatpack — Added 100 ns access time specs — Combined V_{PP} Standby current and V_{PP} Read current into one V_{PP} Standby condition with two test conditions (DC Characteristics table)



INTEL CORPORATION, 2200 Mission College Blvd., Santa Clara, CA 95052; Tel. (408) 765-8080

INTEL CORPORATION (U.K.) Ltd., Swindon, United Kingdom; Tel. (0793) 696 000

INTEL JAPAN k.k., Ibaraki-ken; Tel. 029747-8511