



AP-480

**APPLICATION
NOTE**

**Pentium® PROCESSOR
THERMAL DESIGN
GUIDELINES REV. 2.0**

November 1995



Order Number: 241575-003

Information in this document is provided in connection with Intel products. Intel assumes no liability whatsoever, including infringement of any patent or copyright, for sale and use of Intel products except as provided in Intel's Terms and Conditions of Sale for such products.

Intel retains the right to make changes to these specifications at any time, without notice. Microcomputer Products may have minor variations to this specification known as errata.

*Other brands and names are the property of their respective owners.

†Since publication of documents referenced in this document, registration of the Pentium, OverDrive and iCOMP trademarks has been issued to Intel Corporation.

Contact your local Intel sales office or your distributor to obtain the latest specifications before placing your product order.

Copies of documents which have an ordering number and are referenced in this document, or other Intel literature, may be obtained from:

Intel Corporation
P.O. Box 7641
Mt. Prospect, IL 60056-7641
or call 1-800-879-4683

Pentium® PROCESSOR THERMAL DESIGN GUIDELINES REV. 2.0

CONTENTS	PAGE	CONTENTS	PAGE
1.0 INTRODUCTION	4	4.4 Thermal Resistance	7
1.1 Document Goal	4	5.0 DESIGNING FOR THERMAL PERFORMANCE	8
2.0 IMPORTANCE OF THERMAL MANAGEMENT	4	5.1 Heat Sinks	9
3.0 Pentium® PROCESSOR POWER SPECIFICATIONS	5	5.2 Airflow	13
4.0 THERMAL PARAMETERS	5	5.3 Fans	13
4.1 Ambient Temperature	5	5.4 Thermal Performance Validation	13
4.2 Case Temperature	6	6.0 CONCLUSION	13
4.3 Junction Temperature	6	APPENDIX A	A-1
		APPENDIX B	B-1



1.0 INTRODUCTION

In a system environment, the Pentium® processor's temperature is a function of both the system and component thermal characteristics. The system level thermal constraints imposed on the package are local ambient temperature and thermal conductivity (i.e., airflow over the device). The Pentium processor thermal characteristics depend on the package (size and material), the type of interconnection to the printed circuit board (PCB), the presence of a heat sink, and the thermal conductivity and the power density of the PCB.

All of these parameters are aggravated by the continued push of technology to increase the operating speeds and the packaging density. As operating frequencies increase and packaging size decreases the power density increases and the heat sink size and airflow become more constrained. The result is an increased importance on system design to ensure that thermal design requirements are met for each component in the system.

In addition to heat sinks and fans, there are other solutions for cooling integrated circuit devices. A few of these solutions are: fan mounted on heat sink, heat pipes, thermoelectric (peltier) cooling, liquid cooling, etc. While these alternatives are capable of dissipating additional heat, they have disadvantages in terms of system cost, complexity, reliability, and efficiency. These techniques are more expensive than a passive heat sink and fan. The introduction of active devices can also decrease reliability. Finally, the power efficiency of some of these techniques is poor, and gets worse as the amount of power being dissipated increases. Despite these disadvantages, each of these solutions may be the right one for particular system implementations.

However, for the purpose of this application note, Intel has focused its efforts on describing solutions using passive heat sinks and fans.

1.1 Document Goal

The goal of this document is to provide thermal performance information for the Pentium processor and recommendations for meeting the thermal requirements imposed on systems. This application note attempts to provide an understanding of the thermal characteristics of the Pentium processor and some examples of how the thermal requirements can be met.

2.0 IMPORTANCE OF THERMAL MANAGEMENT

Thermal management of an electronic system encompasses all of the thermal processes and technologies that must be employed to remove and transfer heat from individual components to the system's thermal sink in a controlled manner.

The objective of thermal management is to ensure that the temperature of all components is maintained within functional and absolute maximum limits. The functional temperature limit is the range within which the electrical circuits can be expected to meet their specified performance requirements. Operation outside the functional limit can degrade system performance or cause logic errors. The absolute maximum temperature limit is the highest temperature that a portion of the component may be safely exposed. Temperatures exceeding the limit can cause physical destruction or may result in irreversible changes in operating characteristics. Higher temperatures result in earlier failure of the devices in the system. Every 10°C rise above the operating range means a halving of the mean time between failures.



3.0 Pentium® PROCESSOR POWER SPECIFICATIONS

The Pentium processor's power dissipation and case temperature specs for 60 MHz and 66 MHz are shown in Table 1.

To ensure functionality and reliability of the Pentium processor, maximum device junction temperature must remain below 90°C. Considering the power dissipation levels and typical ambient environments of 40°C to 45°C, the Pentium processor's junction temperatures cannot be maintained below 90°C without additional thermal enhancement to dissipate the heat generated by this level of power consumption.

The thermal characterization data described in Table 2 illustrates that both a heat sink and airflow are needed. The size of heat sink and the amount of airflow are interrelated and can be traded off against each other. For example, an increase in heat sink size decreases the amount of airflow required. In a typical system, heat sink size is limited by board layout, spacing, and component placement. Airflow is limited by the size and number of fans along with their placement in relation to the components and the airflow channels. In addition, acoustic noise constraints may limit the size or types of fans limiting the airflow.

To develop a reliable thermal solution, all of the above variables must be considered. Thermal characterization and simulation should be carried out at the entire sys-

tem level accounting for the thermal requirements of each component.

4.0 THERMAL PARAMETERS

Component power dissipation results in a rise in temperature relative to the temperature of a reference point. The amount of rise in temperature depends on the net thermal resistance between the junction and the reference point. Thermal resistance is the key factor in determining the power handling capability of any electronic package.

Thermal resistance from junction to case (θ_{JC}), and from junction to ambient (θ_{JA}) are the two most often specified thermal parameters for integrated circuit packages.

4.1 Ambient Temperature

Ambient temperature is the temperature of the undistributed ambient air surrounding the package. Denoted T_A , ambient temperature is usually measured at a specified distance away from the package. In the laboratory test environment, ambient temperature is measured 12 inches upstream from the package under investigation. In a system environment, ambient temperature is the temperature of the air upstream to the package and in its close vicinity.

Table 1. Pentium® Processor Power Dissipation

	Package Type	Total Pins	Pin Array	Package Size	Power (Typical)	Power (Max)	Max Case Temp (°C)
Pentium Processor 60 MHz	PGA	273	21 x 21	2.16" x 2.16"	11.9W	14.6W	80
Pentium Processor 66 MHz	PGA	273	21 x 21	2.16" x 2.16"	13W	16W	70



4.2 Case Temperature

Case temperature, denoted T_C , is measured at the center of the top surface (on top of the heat spreader, see Figure 1) of the package, typically the hottest point on the package case. Special care is required when measuring the case temperature to ensure an accurate temperature measurement. Thermocouples are often used to measure T_C . Before any temperature measurements, the thermocouples have to be calibrated. When measuring the temperature of a surface which is at a different temperature from the surrounding ambient air, errors could be introduced in the measurements. The measurement errors could be due to having a poor thermal contact between the thermocouple junction and the surface, heat loss by radiation or by conduction through thermocouple leads. To minimize the measurement errors, it is recommended to use the following approach:

- Use 36 gauge or finer diameter K, T, or J type thermocouples. The laboratory testing was done using a thermocouple made by Omega (part number: 5TC-TTK-36-36).
- Attach the thermocouple bead or junction to the center of the package top surface using high thermal conductivity cements. The laboratory testing was done by using Omega Bond (part number: OB-100).
- The thermocouple should be attached at a 90° angle as shown in Figure 1. When a heat sink is attached a hole (no larger than 0.15") should be drilled through the heat sink to allow probing the center of the package as shown in Figure 1.

- If the case temperature is measured with a heat sink attached to the package, drill a hole through the heat sink to route the thermocouple wire out.

4.3 Junction Temperature

Junction temperature, denoted T_J , is the average temperature of the die within the package.

The junction temperature for a given junction-to-ambient thermal resistance, power dissipation, and ambient temperature is given by the following formula:

$$T_J = P_D * \theta_{JA} + T_A$$

If a heat sink with thermal resistance of θ_{SA} (sink-to-ambient) is used, then the thermal resistance from the junction-to-case, θ_{JC} , is given by the following formula:

$$T_J = P_D * (\theta_{JC} + \theta_{CS} + \theta_{SA}) + T_A$$

where:

θ_{CS} is the thermal resistance from the component (case) to the heat sink.

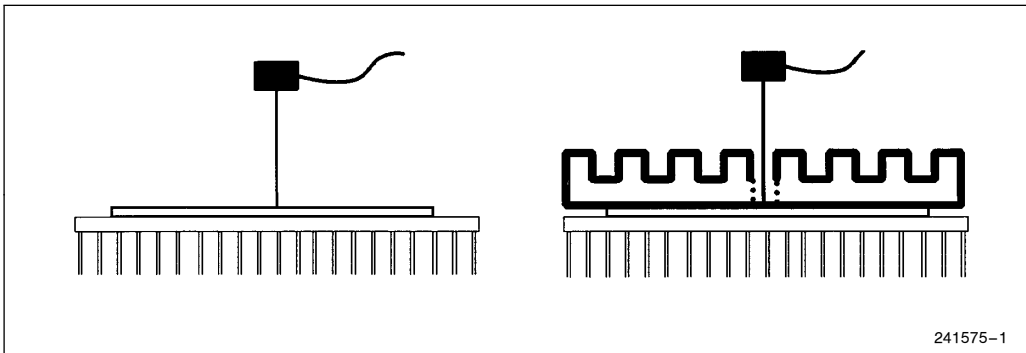

Figure 1. Thermocouple Attachment

4.4 Thermal Resistance

Thermal resistance (Figure 2) values for junction-to-ambient, θ_{JA} and junction-to-case, θ_{JC} , are used as measures of IC package thermal performance. θ_{JC} is a measure of the package's internal thermal resistance along the major heat flow path from silicon die to package exterior. This value is strongly dependent on the material, thermal conductivity, and geometry of the package. θ_{JC} values also depend on the location of the reference point (in this case center of the package top surface), the external cooling configurations and the heat flow paths from the package to the ambient. For example, if a heat sink is attached to the package top surface or more heat is pulled into the board through the pins, the θ_{JC} values measured with reference to the center of the package top surface will change. θ_{JA} values include not only internal thermal resistance, but also the radiative and convective thermal resistance from the package exterior to ambient air. θ_{JA} values depend on the material, thermal conductivity, and geometry of the package and also on ambient conditions such as airflow rates and coolant physical properties.

In order to obtain thermal resistance values, junction temperature is measured using the temperature sensitive parameter (TSP) method. With this method, special design thermal test structures are used which are approximately the same size as the Pentium processor die. The test structure consists of resistors and diodes.

Resistors are used to simulate the Pentium processor power dissipation and thereby heat up the package. Diodes, which are located at the center of the thermal test die, are used to measure the die temperature. The measurements are carried out in a wind tunnel environment. The air flow rate and the ambient temperature are measured 12 inches away from the package in the upstream air.

The parameters are defined by the following relationships:

$$\theta_{JA} = (T_J - T_A)/P_D$$

$$\theta_{JC} = (T_J - T_C)/P_D$$

$$\theta_{JA} = \theta_{JC} + \theta_{CA}$$

where:

θ_{JA} = junction-to-ambient thermal resistance (°C/W)

θ_{JC} = junction-to-case thermal resistance (°C/W)

θ_{CA} = case-to-ambient thermal resistance (°C/W)

T_J = average die (junction) temperature (°C)

T_C = case temperature at a pre-defined location (°C)

T_A = ambient temperature (°C)

P_D = device power dissipation (W)

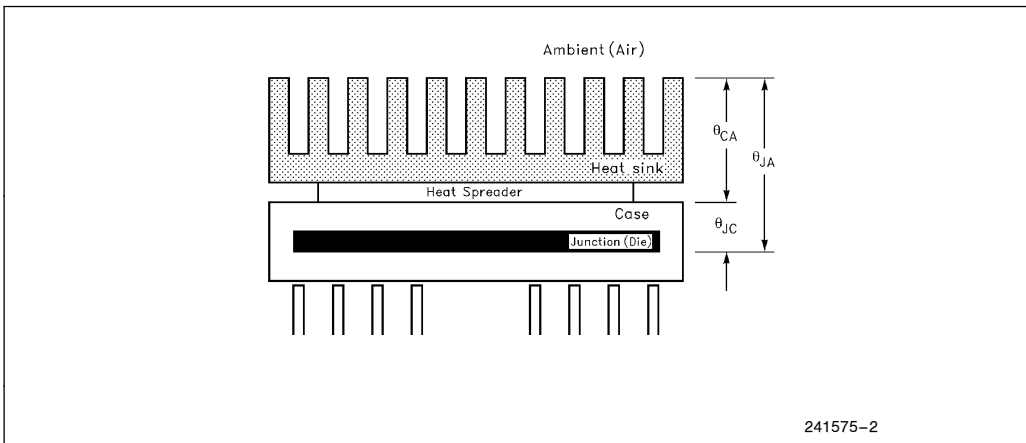

Figure 2. Thermal Resistance Parameters



Table 2 lists the junction-to-case and case-to-ambient thermal resistances for the Pentium processor (with and without a heat sink).

Table 2. Thermal Characterization Data

	θ_{JC}	θ_{CA} **vs Airflow (ft./min.)					
		0	200	400	600	800	1000
With 0.25" Heat Sink	0.6	8.3	5.4	3.5	2.6	2.1	1.8
With 0.35" Heat Sink	0.6	7.4	4.5	3.0	2.2	1.8	1.6
With 0.65" Heat Sink	0.6	5.9	3.0	1.9	1.5	1.2	1.1
Without Heat Sink	1.2	10.5	7.9	5.5	3.8	2.8	2.4

NOTE:

Heat Sink: 2.1 in² base, omni-directional pin Al heat sink with 0.050 in. pin width, 0.143 in. pin-to-pin center spacing and 0.150 in. base thickness. Heat sinks are attached to the package with a 2 to 4 mil thick layer of typical thermal grease. The thermal conductivity of this grease is about 1.2 w/m c.

** θ_{CA} values shown in this table are typical values. The actual θ_{CA} values depend on the air flow in the system (which is typically unsteady, non-uniform and turbulent) and thermal interactions between Pentium CPU and surrounding components through PCB and the ambient.

5.0 DESIGNING FOR THERMAL PERFORMANCE

At this point the application note turns from describing the characteristics that define thermal performance to describing how designers should use these characteristics to assess thermal requirements of PC system designs. The Pentium processor specifies a maximum case temperature, T_C , of 70°C @ 66 MHz. This case temperature limit along with the Pentium processor's power and thermal resistance characteristics can be used to determine the ambient temperature required to keep the Pentium processor operating within its specified limits. Using these parameters in the following equations:

$$T_A = T_C - (P * \theta_{CA})$$

$$T_A = 70^\circ\text{C} - (16\text{W} * 10.5^\circ\text{C}/\text{W})$$

$$T_A = -98^\circ\text{C}$$

The maximum ambient temperature required in a Pentium processor system without any additional thermal enhancement is -98°C at 66 MHz. Obviously, this ambient temperature is impractical and unachievable in a PC system. In order to be able to maintain the case temperature at 70°C in a typical system ambient with air temperature of 40°C to 45°C, the thermal resistance between the case and the ambient must be reduced.



5.1 Heat Sinks

The most common way to improve the package thermal performance is to increase the surface area of the device by attaching a large piece of metal (a heat sink) to the package. The heat sink is usually made of Aluminum and is chosen for its price/thermal-performance ratio. There are materials that offer higher conductivity such as copper, but cost becomes prohibitive. To maximize the flow of heat for a given junction temperature rise over the ambient temperature, the thermal resistance from heat sink to air can be reduced by a) maximizing the surface area, and b) maximizing the air flow across the surface area (maximizing air flow **through** heat sink fins in most cases).

Intel has used test data to determine what size of heat sink and airflow is needed to properly cool a Pentium processor system. The data was derived assuming an

adhesive attach process that offers thermal resistance of about 0.2°C/W.

The testing was done in a wind tunnel in the configuration (in Figure 3) where the heat sink was mounted on a real Pentium processor package with a thermal die mounted inside to generate the 16W of power. The package is then mounted in a socket which is soldered to a 2-layer PCB that brings power to the die.

Based on these tests, three specific heat sink and airflow combinations have been identified that properly dissipate the Pentium processor's 16W and maintains a case temperature below 70°C @ 66 MHz. The three heat sinks are shown in Figure 4.

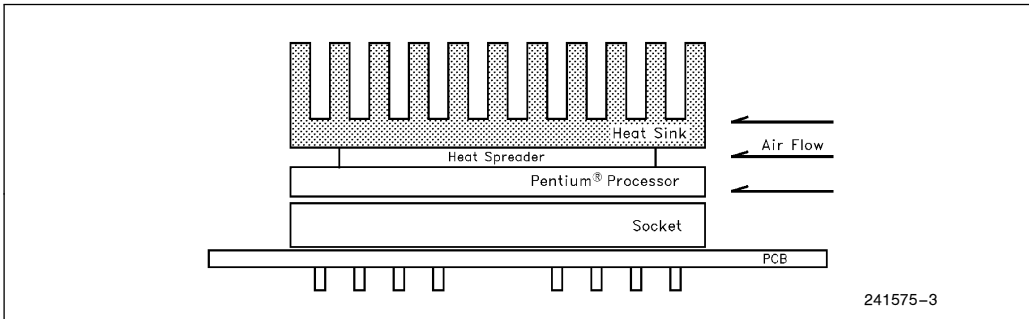

Figure 3. Improving Thermal Performance

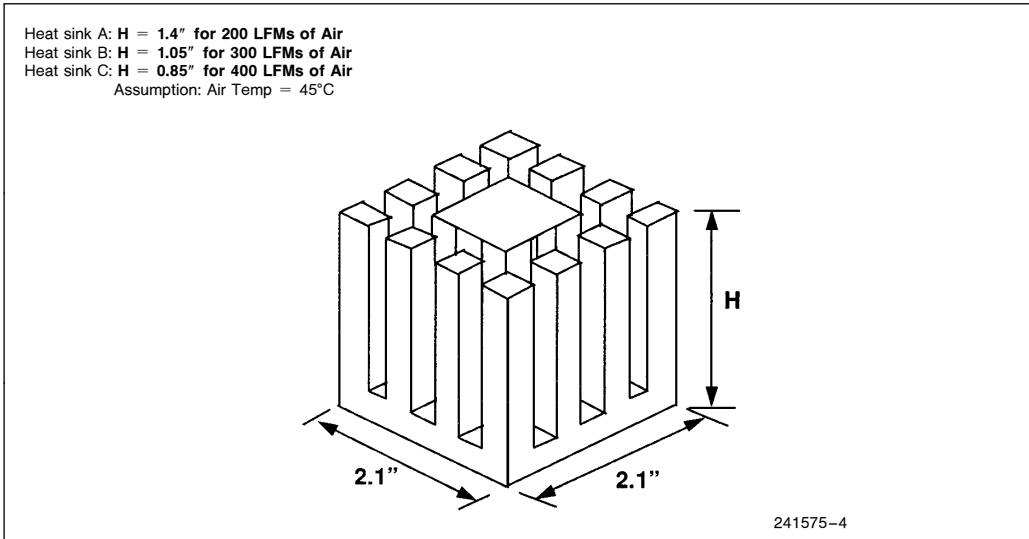

Figure 4. Recommended Combinations





In addition, testing has been done to provide more general guidelines which allow deviating from the above conditions. These guidelines allow systems to derive various combinations of heat sink size and airflow that ensure the Pentium processor thermal specifications are met. For example, by increasing the heat sink x-y dimensions and extending it over the package footprint, the heat sink height can be reduced while maintaining the same thermal performance as the taller heat sink with the same footprint as that of the package. The first three charts (Figures 5, 6, 7) show the thermal resistance as a function of heat sink size and airflow. The last three charts (Figures 8, 9, 10) show the power dissipa-

tion achievable with a given heat sink size and airflow. The power dissipation calculations assume $T_C = 70^\circ\text{C}$ @ 66 MHz, $T_A = 45^\circ\text{C}$, and $\theta_{JC} = 0.6^\circ\text{C/W}$.

$$P_{\max} = (T_C - T_A) / \theta_{CA} = 25 / \theta_{CA}$$

A key assumption in all of these calculations is that a perfect thermal connection can be achieved between the case and the heat sink. One can extrapolate the heat sink solutions by adding the additional thermal resistance of any chosen heat sink attach process. See Appendix B for case to heat sink thermal interface options.

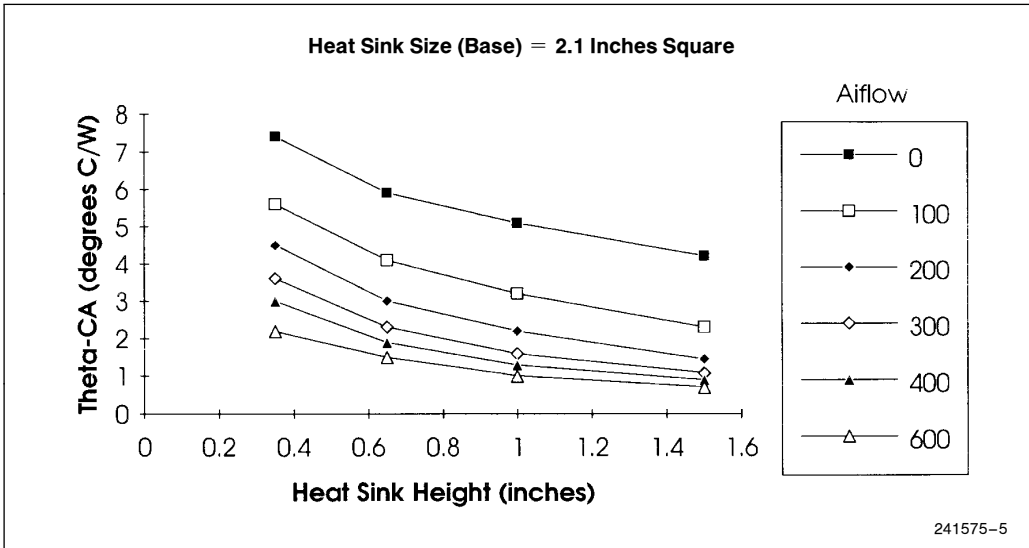

Figure 5. Thermal Resistance

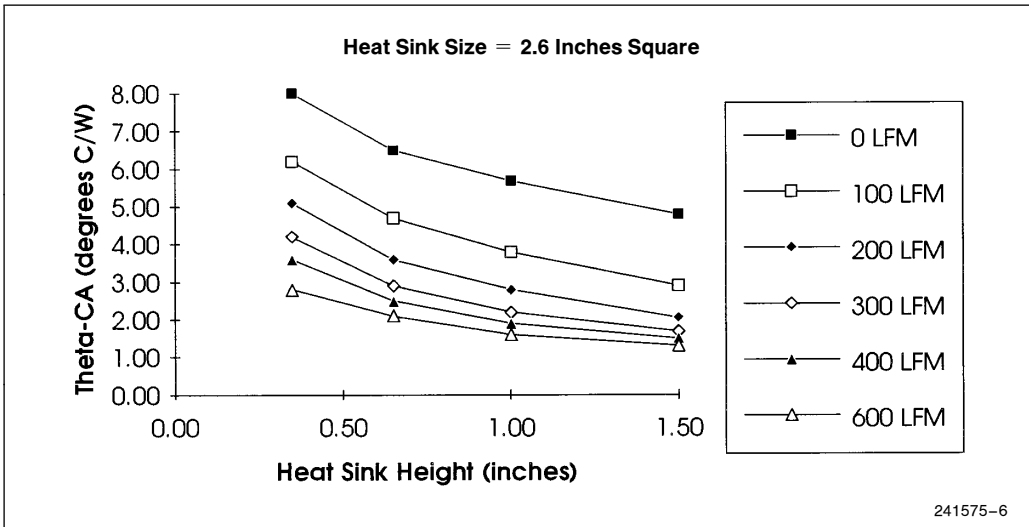

Figure 6. Thermal Resistance

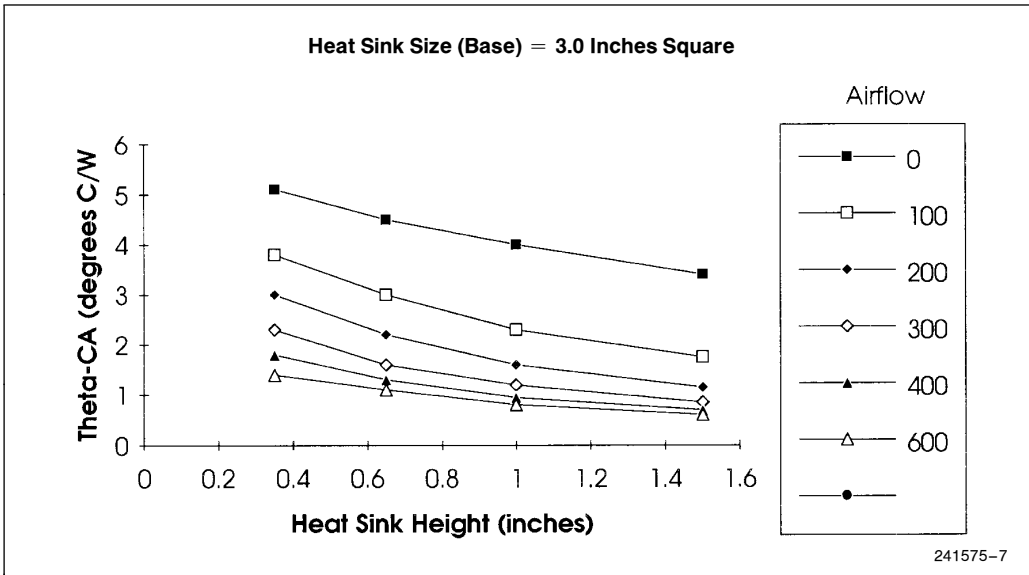

Figure 7. Thermal Resistance

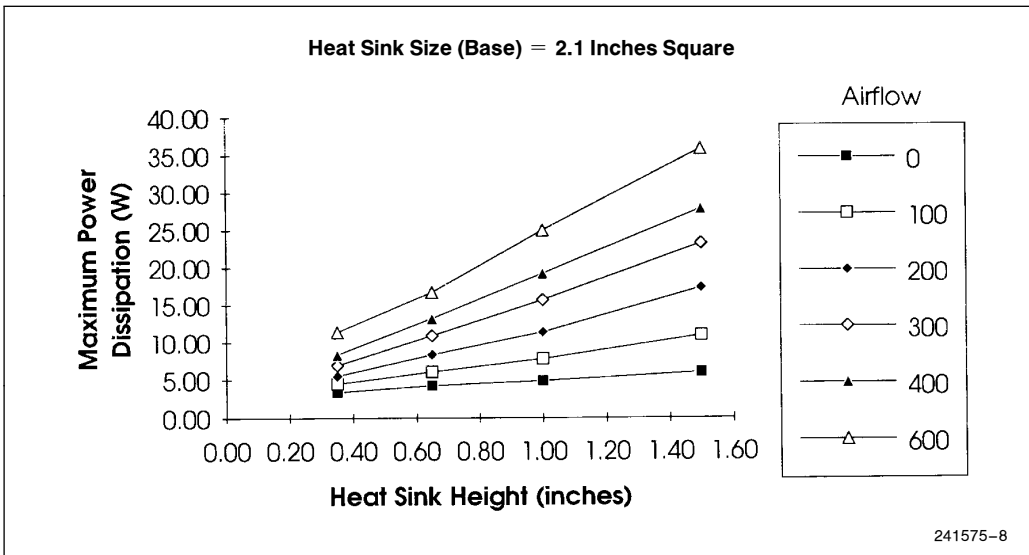

Figure 8. Power Dissipation



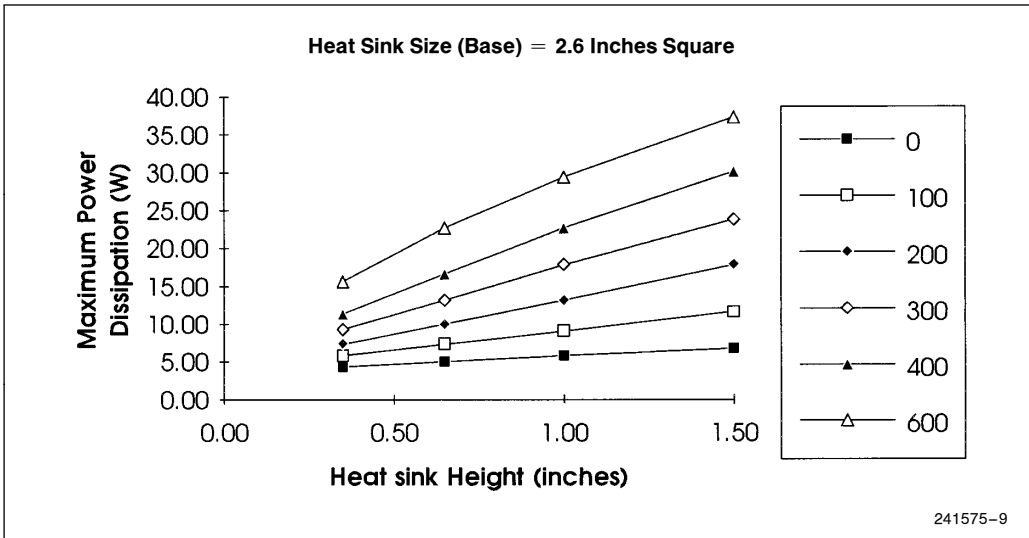

Figure 9. Power Dissipation

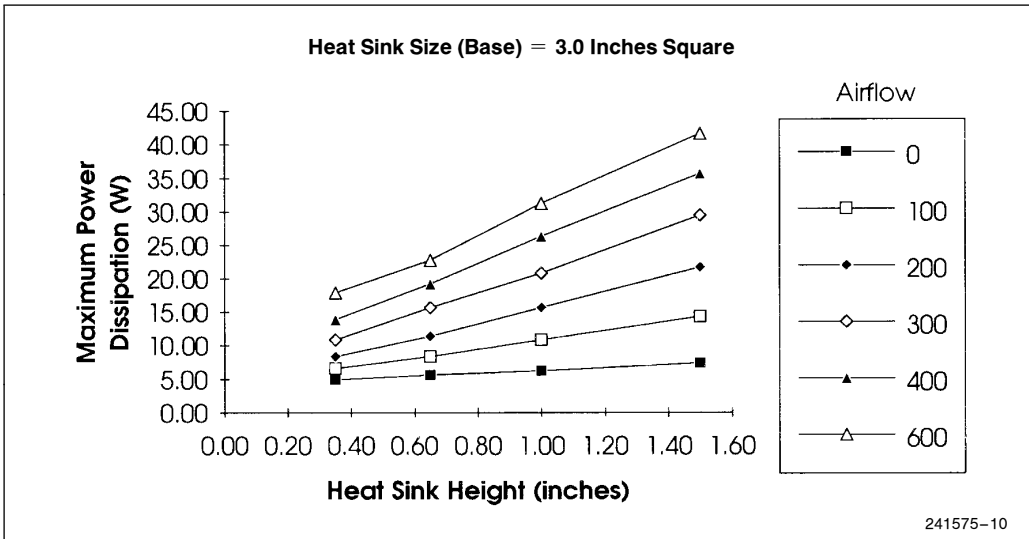

Figure 10. Power Dissipation



5.2 Airflow

To improve the effectiveness of heat sinks it is important to manage the airflow so as to maximize the amount of air that flows over the device or heat sink's surface area. In the system, the air flow around the processor can be increased by providing an additional fan or increasing the output of existing fan. If this is not possible, baffling the airflow to direct it across the device may help. This means the addition of sheet metal or objects to guide the air to the target device. Often the addition of simple baffles can eliminate the need for an extra fan. In addition, the order in which air passes over devices can impact the amount of heat dissipated.

5.3 Fans

Fans are often needed to assist in moving the air inside a chassis. A typical variable speed fan capable of up to 100 CFM of air can be found for approximately \$10.

The airflow rate is usually directly related to the acoustic noise level of the fan and system. Therefore maximum acceptable noise levels may limit the fan output or the number of fans selected for a system.

A fan may be placed at the top of a heat sink to produce direct air impingement on the heat sink for efficient heat removal. A key issue with fans is their reliability. Although many fans are rated for approximately 50,000 hours of operation, operating conditions such as operating temperature, pressure drop across the fan and the particles in the air can significantly reduce the fan's useful life.

5.4 Thermal Performance Validation

The recommended thermal solutions in Section 5.1–5.3 are only design guidelines. Since there are many variables that can effect thermal performance in an actual system, thermal performance should always be validated experimentally, following the case temperature measurement technique described in Section 4.2.

6.0 CONCLUSION

As the complexity of today's microprocessors continues to increase so do the power dissipation requirements. Care must be taken to ensure the additional heat resulting from the power is properly dissipated. As documented, the heat can be dissipated using passive heat sinks, fans and/or active cooling devices.

The simplest and probably most cost effective method is to use a heat sink and a fan. The size of the heat sink and the output of the fan can be varied to balance the tradeoffs between size and space constraints versus noise. For example, if space is available a 1.4" high heat sink can be used with only 200 LFM to cool the 66 MHz Pentium processor and the 16W it dissipates. Another example in which space is restricted shows a 0.7" high heat sink can be used if approximately 500 LFM of airflow is provided.

These are not the only valid solutions, but both provide adequate cooling to maintain the Pentium processor case temperature at or below the 70°C @ 66 MHz specified limit. By maintaining this specification, the system can guarantee proper functionality and reliability of the Pentium processor.

APPENDIX A EXAMPLES

Thermal management examples, designing with the Pentium processor. Using the best known methods.

Appendix Goal

The goal of this appendix is to measure the operating temperatures in a real system versus the wind tunnel laboratory measurements. These experiments are done with heat sinks that are similar to the ones suggested in Section 5.1 of the main document. The thermocouples and attachment methods suggested in Section 4.2 of the main document are also used. The appendix begins by reviewing the variables that the system designer has control over and uses tables to describe thermal resistance in the context of where the system designer can have the most effect. The importance of the case to heat sink thermal interface and correct attachment methods are reviewed and different options given. The appendix proceeds to describe the system used for these tests and the tools and equipment needed. The lab set up procedures are discussed in detail and the measurements are presented with comments at the conclusion.

WHAT ARE THE VARIABLES?

Table A-1 shows the cooling options that customers can control when designing a system. From Table A-1 it is obvious that changing the heat sink and air flow are the two most effective ways for a system designer to affect the thermal performance of a system.

Table A-1. Variables

COOLING OPTIONS UNDER CUSTOMER CONTROL	
Variables	Options for Cooling
Device	<ul style="list-style-type: none"> • Use Power Management SW in the System • Clock the Device at a Lower Speed
Heat Sink	<ul style="list-style-type: none"> • Increase Heat Sink Area, Width or Height • Use Interface Materials with Lower Thermal Resistance • Use Active Cooling Devices • Use a Combination of Active and Passive Cooling Devices
Air Flow	<ul style="list-style-type: none"> • Increase Air Flow • Manage Air Flow • Place Hottest IC's near Highest Airflow
Ambient Temperature	<ul style="list-style-type: none"> • Place System in a Controlled Climate



Figure A-1 sums up the thermal tradeoff picture succinctly. Looking at Figure A-1 reiterates the previous statement that increasing the heat sink size and air flow rate provide the largest thermal performance improvements. In addition it shows the variables that are constant. Note that the θ_{JC} (junction-to-case thermal resistance) of the Pentium processor is fixed and a system designer can have no effect on this parameter. Also note that the θ_{CS} (case-to-heat sink thermal resistance) is a constant. Even though θ_{CS} is shown as a constant in Figure A-1 it can move up and down the Y axis depending on the interface material chosen. The case to heat sink interface is critical to the overall success of the thermal solution and cannot be overlooked. The next section will go into detail on this subject.

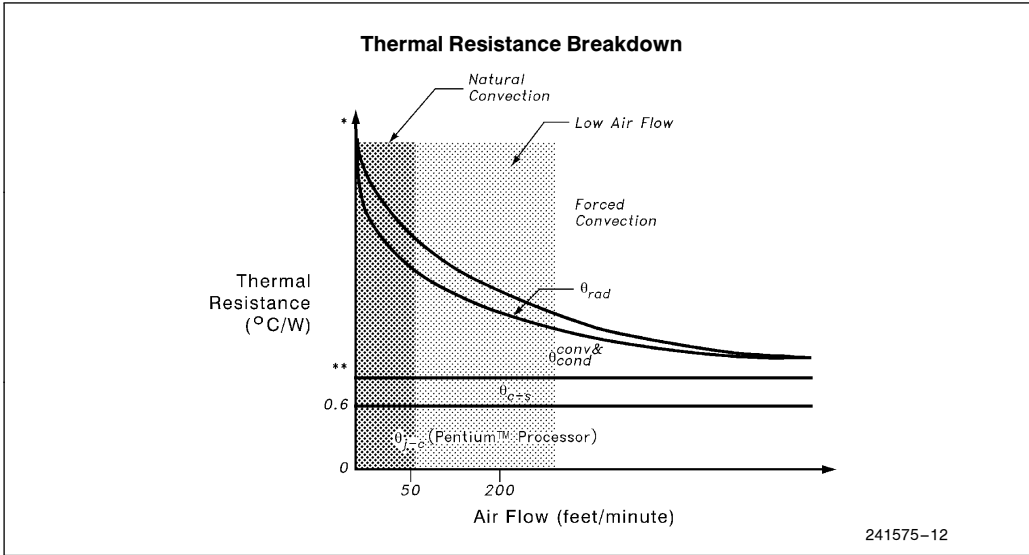

Figure A-1. Thermal Resistance



The main of purpose Figure A-2 is to show that packages and heat sinks are not perfectly flat and this requires that the air gap be filled with an interface material that has a lower thermal resistance than air. The whole point is to try and minimize the contact thermal resistance. The different types of thermal interface materials are listed to show the wide array of materials available to the system designer. Intel's data books have a mechanical section that list the flatness of the package. Heat sink vendors should be able to provide specifications for their heat sink offerings.

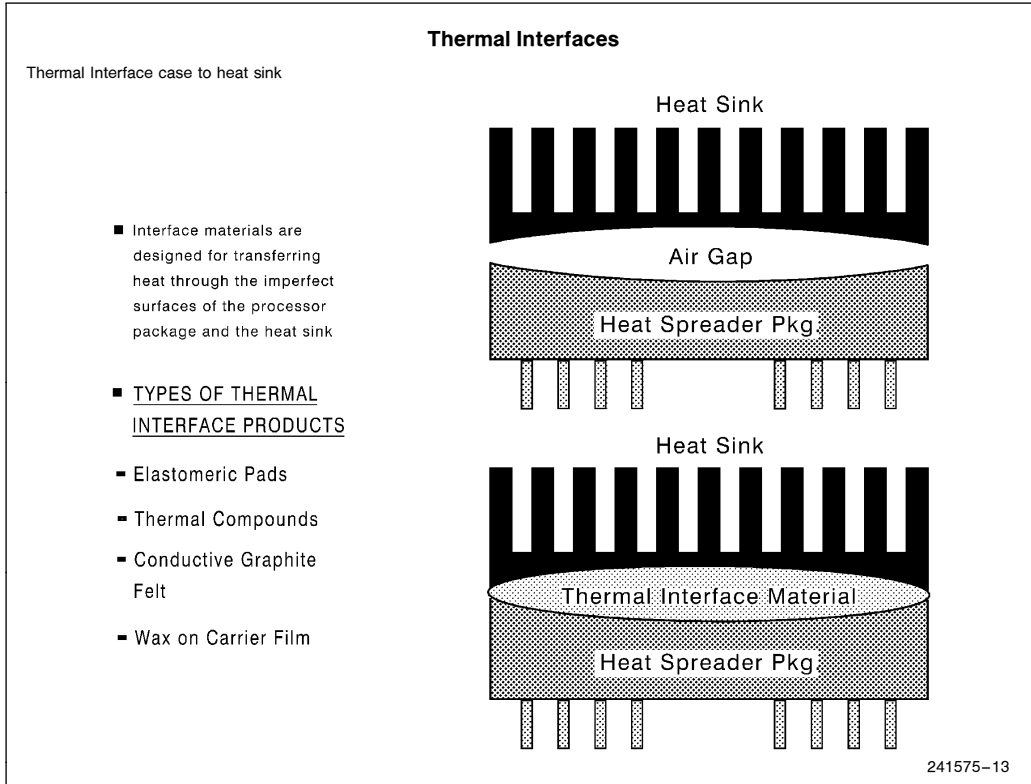

Figure A-2. Thermal Interfaces



The next section (Figures A-3 through A-5) covers attachment methods which generally fall into the categories shown; epoxies, double sided tapes or manual clips to either chip or socket.

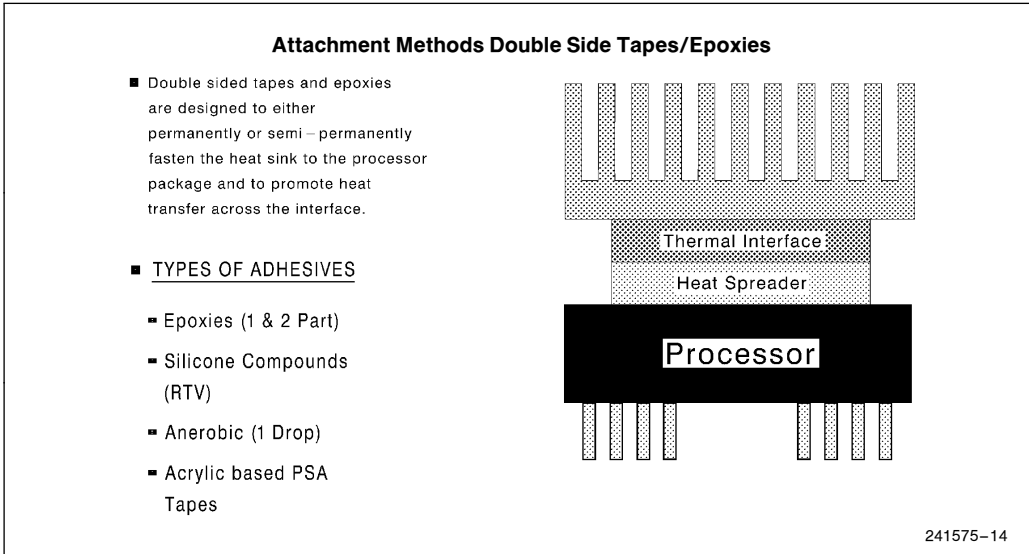

Figure A-3. Attachment Methods

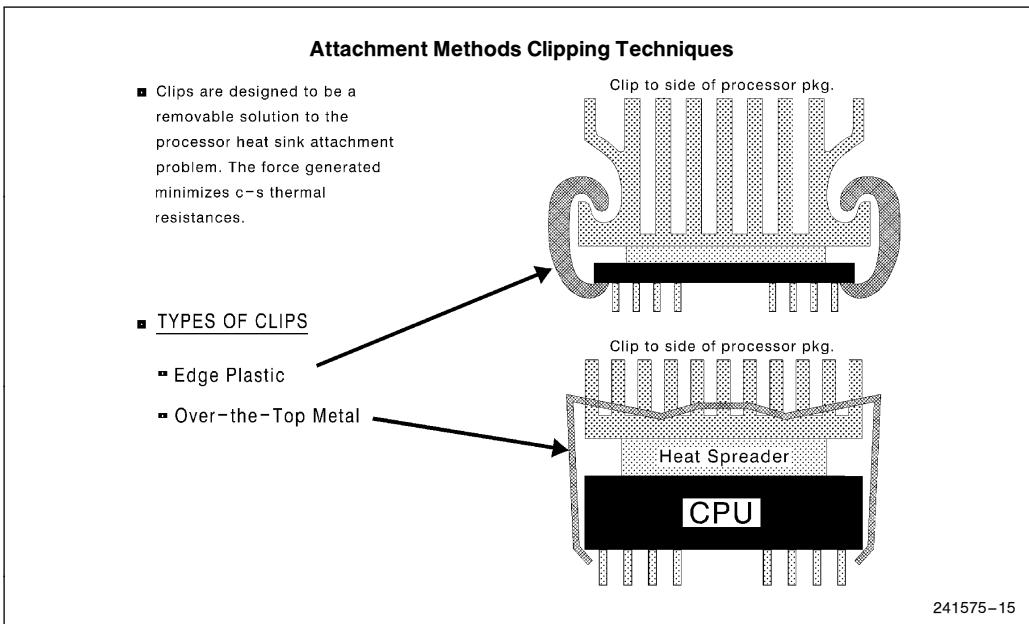

Figure A-4. Attachment Methods



Note that some clips don't allow the package to be pushed all the way into the socket and this could be a problem with short lead packages. The main advantage of this type of system is that a low profile socket can be used to lower the height of the processor heat sink assembly.

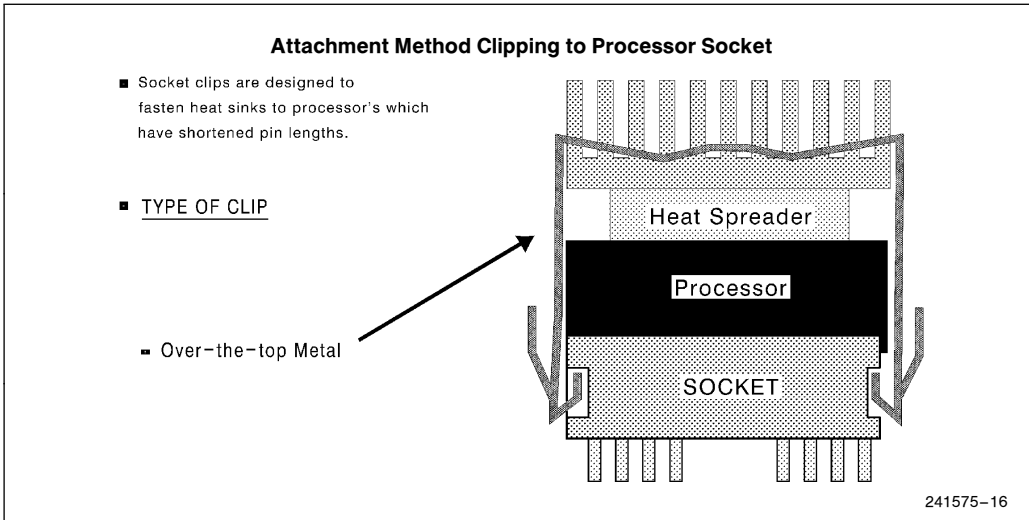

Figure A-5. Attachment Methods

Table A-2 lists pros and cons of the different attachment methods covered.

Table A-2. Attachment Methods

ATTACHMENT METHODS		
	ADVANTAGES	DISADVANTAGES
DOUBLE SIDED TAPES	<ul style="list-style-type: none"> • Quick to Use • Low Installed Cost • Compliant 	<ul style="list-style-type: none"> • High Thermal Resistance • Requires Flat Interfaces • Assembly Contact Pressure
EPOXIES	<ul style="list-style-type: none"> • Low Potential Thermal Resistance • Low Contact Pressure 	<ul style="list-style-type: none"> • Mixing, Curing, Messy • Timing Consuming (if not automated) • CTE Stress, High Rigidity • Variable Thickness (theta)
CLIPS	<ul style="list-style-type: none"> • Centralized Pressure Points • Removable • Easily Installed • Solution to Upgrade • Accommodates Wide Tolerance 	<ul style="list-style-type: none"> • Removable • Force Limits vs Assembly • Insufficient Shock and Vibration Data • Potential for Loss of Pressure

The materials chart Figure A-6 shows the performance of each type of thermal interface material. Note that even though thermal grease has a deserved reputation for being messy and harder to control it still performs well as a thermal interface. All the examples that are shown in Appendix A use thermal grease as the case to heat sink interface.

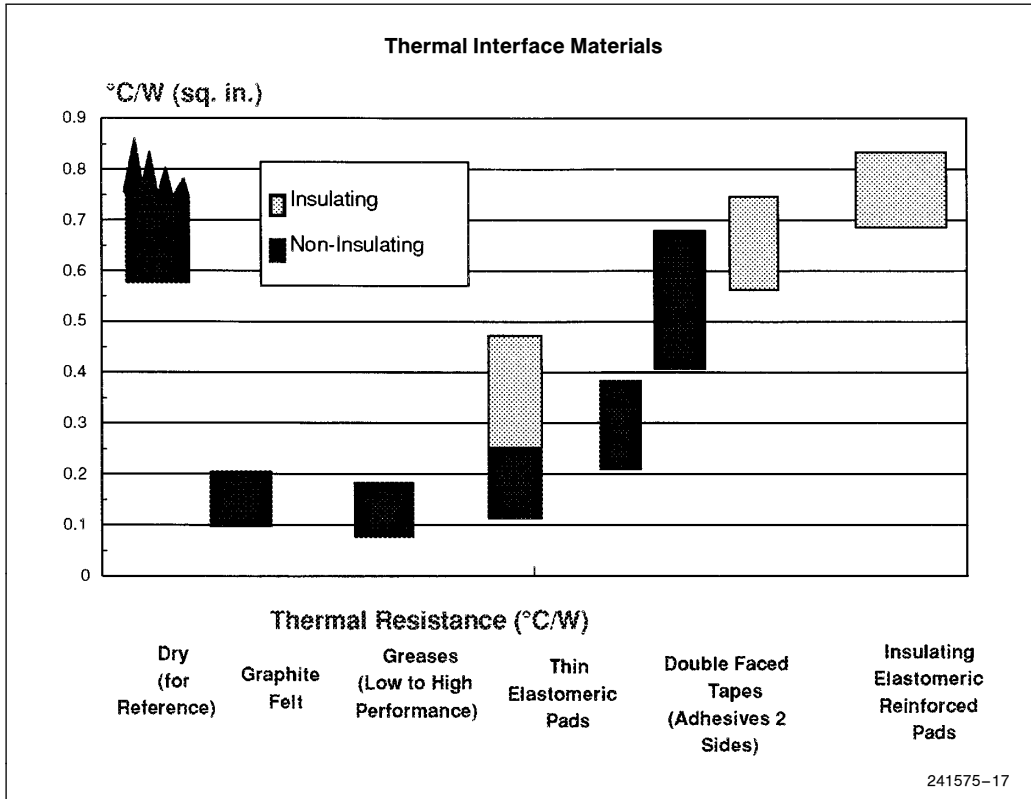

Figure A-6. Materials



The next step is to choose a heat sink. Figure A-7 shows the wide range of choices and the cost associated with each technology.

Now that all the variables and options are known for this problem we can proceed on to do some real system measurements using the recommendations and data shown in the first part of this application note.

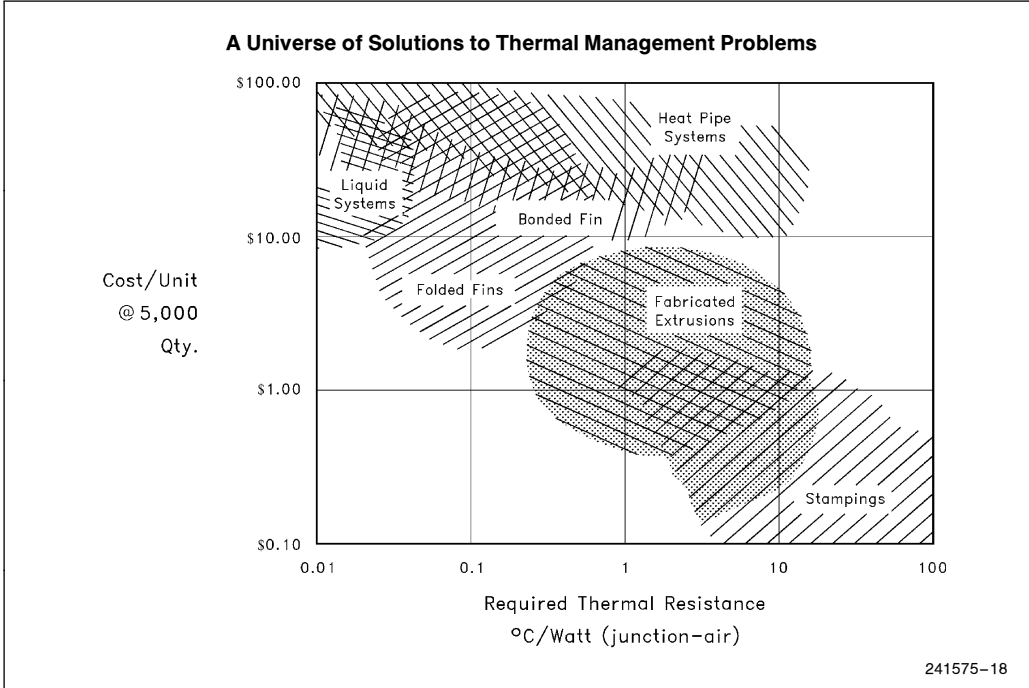

Figure A-7. Solutions



Examples

For all the examples in this section we used a 40 MHz system with a Pentium processor and 256K cache. A picture of the system under test is shown in Figure A-8 with the covers off to show the placement of the Pentium processor and the associated cache components. A 40 MHz system was used because it was the only one available at the time the testing was done.

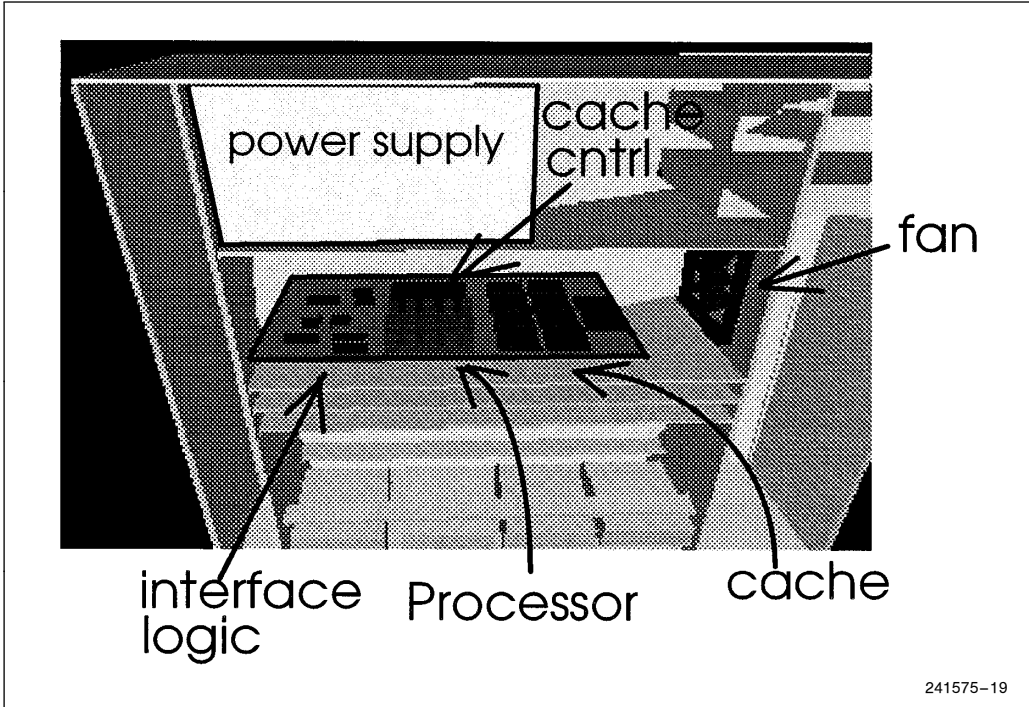

Figure A-8. Pentium® Processor System



Objectives

- To measure a Pentium processor system operating under real working conditions.
- To compare the measured results to the predicted results shown in the beginning of this application note. The reader should always keep the main goal in mind; **the main goal is always to meet the case temperature specification for the Pentium processor.** Any combination of heat sink and air flow rate is fine as long as the case temperature specification is met. The heat sinks used in test # 1 thru # 4 will match the suggested heat sinks as close as possible to accurately correlate with the wind tunnel data. This is meant to illustrate how a system designer might start by using the suggested heat sinks and air flow rates as starting points to thermally tune their particular system. Test # 5 uses a heat sink and a fan combination. The fan heat sink is best described as a fan attached directly to the heat sink on the Pentium processor. It is an active device used for spot cooling ICs. We will concentrate on traditional passive heat sink solutions with only one set of measurements being done for a fan heat sink assembly.

Tools and Equipment

1. Pentium processor-based system running at 40 MHz.
2. Hot wire anemometer to measure airflow rate.
3. Thermocouples and high thermal conductivity cement as recommended in the application note.
4. Homemade jig for accurate and repeatable attachment of the thermocouples to the package.
5. Homemade power supply isolation socket for setting the V_{CC} and reading the I_{CC} of the processor independently of the rest of the system.
6. Adjustable power supply with adequate current capabilities and both current and voltage read out.
7. Multimeter to read the voltage and current.
8. Cables to connect everything up.
9. Software test suite that simulates “worst case conditions for a typical real application.” In this case it was Microsoft Excel and Word for Windows test suites.
10. Drill and drill bits.
11. Thermal grease.

The lab procedure was as follows:

Preparing the System

1. Load the test software on the system disk (or floppy) and make sure everything runs correctly before you start. After everything works satisfactorily proceed to the next step.
2. Remove the covers, choose several places (random) around the processor to measure the air flow of the system. Then drill holes large enough to allow the

anemometer to be inserted. Five holes were drilled in the system cover.

3. In this case we had a 12" long $\frac{1}{4}$ " diameter directional anemometer. To get more repeatable measurements the shaft of the probe was marked with a pencil to get the same depth, into the box, for each measurement
4. We then removed the processor card from the chassis (use anti-static procedures to prevent IC damage).
5. Remove the Pentium processor from the card and install the isolation socket.

Preparing the Pentium Processor for Testing

1. Using the jig carefully attach the thermocouple to the center of the processor package using cement and let it cure as recommended by the manufacturer of the cement.
2. Drill holes no larger than 0.125" in the centers of the heat sinks to be tested just large enough to get the thermocouple wires through the hole. In the case of the fan heat sink, the fan was removed and the heat sink was drilled the same as the others and then re-assembled. Each of the holes were counter sunk on the bottom to better conform to the tear drop shape the thermocouple and cement naturally forms into. The idea is to not disturb or break the contact between the cement and the package. If it is broken or cracked the measurements will be incorrect
3. Apply the thermal grease (less than 0.004" thick) evenly, with no voids, to the processor package.
4. Slide the heat sink down the thermocouple wires being careful not to disturb the thermocouple while at the same time firmly seating the heat sink to the package. Attach the plug for the temperature meter to the other end of the thermocouple wire terminals.
5. Re-install the processor/thermocouple/heat sink assembly into the isolation socket on the processor board, again being careful not to disturb the thermocouple connection.

Preparing for Measurements

1. Re-install the processor card into the system.
2. Connect the power supply wires to the power supply and the isolation socket.
3. Connect the multimeter to the the power supply to monitor the V_{CC} and set the power supply meter to measure I_{CC} .
4. Connect the thermocouple to the meter.
5. Turn on the processor power supply and then the system supply.
6. Wait for the system to boot and then run the test software.



Thermal Measurements

The next step was to determine the baseline airflow in the system without a heat sink attached to the processor. Measure the airflow at several locations using the access holes in the system and the marks on the probe to ensure accurate placement of the probe and repeatability of the measurements. Table A-3 shows the results. Be cautious when placing the fan in a system relative to the processor. All fans have a dead spot (low airflow) in the center of the fan. Avoid the dead spot. Even several inches away from the fan the dead spot can influence airflow considerably.

Test # 1

The next step is to compare how close the suggested values and tables are to the measured results. Use the formulas described in the beginning of the application note and the values from Table A-4.

$$P_D = V_{CC} * I_{CC} = (1.82 * 4.89) = 8.827W$$

$$\theta_{JC} = (T_J - T_C) / P_D = 0.6$$

$$\theta_{JA} = (T_J - T_A) / P_D$$

$$\theta_{CA} = \theta_{JA} - \theta_{JC} = [(T_J - T_A) - (T_J - T_C)] / P_D = [T_C - T_A] / P_D$$

$$\theta_{CA} = (55.3 - 29) / (1.8 * 4.85) = 24 / 8.827 = 2.97$$

$\theta_{CA} = 2.7^\circ C/W$ is the measured value in the system for this configuration.

Table A-3. Baseline Airflow

Airflow Measured, LFM	120–160
Location of probe	~ 2 inches (upstream from the fan) @ center of the processor (above the heat sink)

Table A-4. Test Conditions Test # 1

Heat Sink Size, Inches H x W	Temperature, degrees C			I _{CC} Amps	V _{CC} Volts	Air Flow LFM
	Room T _A	System T _A	Case T _C			
1.2 x 2.1 sq.	23	29	55.3	1.82	4.85	100–150



The graph (Figure A-9) from the application note, for heat sink size size of 2.1" x 2.1", is used to compare the predicted θ_{CA} , for a 1.2" tall heat sink, to the measured value of θ_{CA} .

The predictions from the graph (Figure A-9) are:

- $\theta_{CA} = 2.9^{\circ}\text{C/W}$ @ 100 LFM
- $\theta_{CA} = 2.4^{\circ}\text{C/W}$ @ 150 LFM
- $\theta_{CA} = 1.9^{\circ}\text{C/W}$ @ 200 LFM

And the measured value is:

$\theta_{CA} = 2.97^{\circ}\text{C/W}$ @ 100–150 LFM

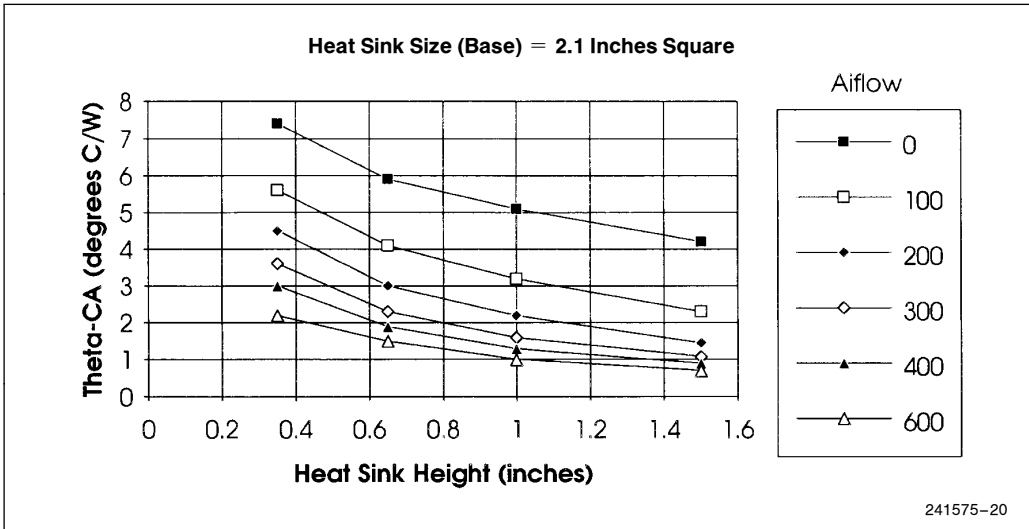

Figure A-9. Thermal Resistance

Table A-5. Test Conditions Test # 2

Heat Sink Size, Inches H x W	Temperature, degrees C			I _{CC} Amps	V _{CC} Volts	Air Flow LFM
	Room T _A	System T _A	Case T _C			
0.5 x 2.1 sq.	22	29	58.3	1.81	4.85	100–150



Test #2

The same test only the heat sink height was reduced to 0.5 inch height.

$$\theta_{CA} = (T_C - T_A)/P_D$$

$$\theta_{CA} = 58.3 - 29/8.79 = 3.33^\circ\text{C/W}$$

The 2.1" x 2.1" graph (Figure A-9) from test #1 is used again and it predicts:

$$\theta_{CA} = 4.9^\circ\text{C/W @ 100 LFM}$$

$$\theta_{CA} = 4.3^\circ\text{C/W @ 150 LFM}$$

$$\theta_{CA} = 3.8^\circ\text{C/W @ 200 LFM}$$

And the measured value is:

$$\theta_{CA} = 3.33^\circ\text{C/W @ 100-150 LFM}$$

Test #3

This test is the same as test #2 except that processor board to board spacing was reduced to 0.6 inches using

a cardboard baffle to simulate a system with very tight board spacing. An existing system that is upgrading from an Intel 486 processor to the Pentium processor might have this type of spacing. Note that this particular configuration actually has more airflow than test #2. It could have just as easily been lower. It all depends on the particular system being measured.

$$\theta_{CA} = (T_C - T_A)/P_D$$

$$\theta_{CA} = 70.3 - 27/8.79 = 4.9^\circ\text{C/W}$$

The 2.1" x 2.1" graph (Figure A-9) from test #1 is used again to predict the θ_{CA} :

$$\theta_{CA} = 4.3^\circ\text{C/W @ 150 LFM}$$

$$\theta_{CA} = 3.8^\circ\text{C/W @ 200 LFM}$$

$$\theta_{CA} = 3.0^\circ\text{C/W @ 300 LFM}$$

And the measured value is:

$$\theta_{CA} = 4.9^\circ\text{C/W @ 175-200 LFM}$$

Table A-6. Test Conditions Test #3

Heat Sink Size, Inches H x W	Temperature, degrees C			I _{CC} Amps	V _{CC} Volts	Air Flow LFM
	Room T _A	System T _A	Case T _C			
0.5 x 2.1 sq.	23	27	70.3	1.81	4.85	175-200

Table A-7. Test Conditions Test #4

Heat Sink Size, Inches H x W	Temperature, degrees C			I _{CC} Amps	V _{CC} Volts	Air Flow LFM
	Room T _A	System T _A	Case T _C			
0.65 x 3.1 sq.	23	29	55.3	1.8	4.85	100-140



Test #4

This test uses a 0.65" tall heat sink that is 3.1" sq. This type of heat sink might be used when height is limited and there is room to spread out by adding more area to the heat sink base.

$$\theta_{CA} = (T_C - T_A) / P_D$$

$$\theta_{CA} = (55.3 - 29) / 8.73 = 3.0$$

The 3.0" x 3.0" graph (Figure A-10) from the application note is used since it is similar to the heat sink used. The 3.0" x 3.0" graph predicts:

$$\theta_{CA} = 3.0^{\circ}\text{C/W @ 100 LFM}$$

$$\theta_{CA} = 2.6^{\circ}\text{C/W @ 150 LFM}$$

And the measured value is:

$$\theta_{CA} = 3.0^{\circ}\text{C/W @ 100-140 LFM}$$

Test #5

The last test was done using a fan/heat sink assembly that has become popular for prototyping, debug and spot cooling in some situations. We were not able to measure the airflow on the processor with this configuration because the air flow is not directional enough to get a reading with the probe available. The case temperature however was monitored by mounting a thermocouple in the same manner used above. We did modify the setup by bringing the thermocouple wires out the side to clear the fan. This will change the measurements the thermocouple produces and should be factored into any data. We do not have any wind tunnel data on the fan/heat sink combination. Note that the case temperature is within specification.

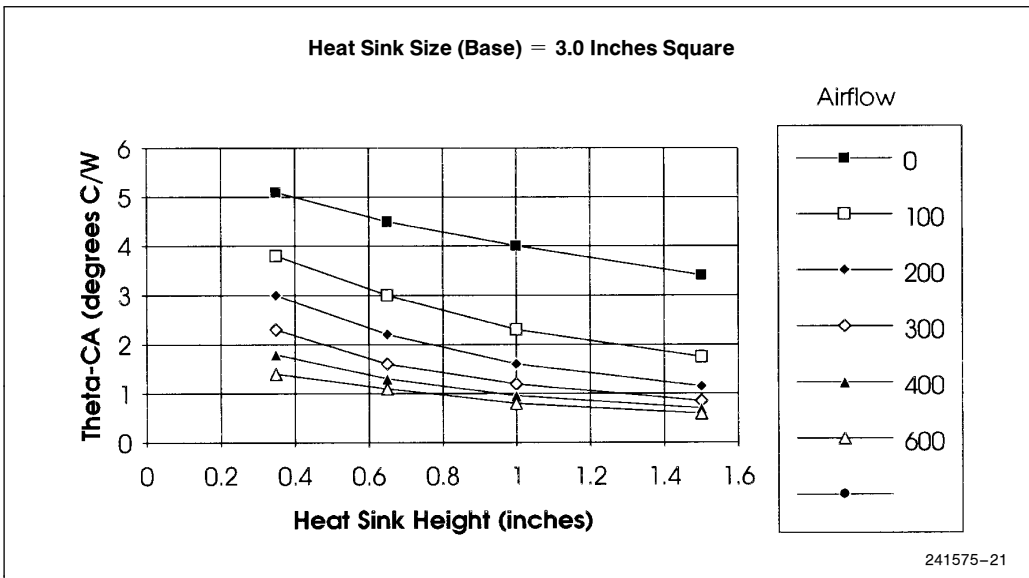

Figure A-10. Thermal Resistance

Table A-8. Test Conditions Test #5

Heat Sink Size, Inches H x W	Temperature, degrees C			I _{CC} Amps	V _{CC} Volts	Air Flow LFM
	Room T _A	System T _A	Case T _C			
HS/Fan	23	29	46	1.8	4.85	120-160

Conclusion

Table A-9 shows all the tests in one table. The data shows that the suggestions in the application note are a very good starting point to begin tuning any Pentium processor system and that there is no one cookbook answer that fits all systems because of the complexity of air flow and variations from each type of system. Indeed the results show that airflow can be changed dramatically even in the same system by changing one variable. For example test #2 and #3 are exactly the same except that board to board spacing was reduced significantly. Note that case temperature rose significantly even though the airflow sensor was reading a higher value. This suggests that the airflow through the heat sink was lower even though the anemometer, 2 inches away, was reading higher airflow at its position. Note also that test #2 more closely approximates the wind tunnel test setup because it has open space above the board instead of a board nearby. This is also why the predicted data versus the measured data is so far off for test #3, while test #2 is very close to the predicted results.

Test #1 and #4 demonstrate a fundamental principle of the physics involved. If you have the same airflow

and must reduce the height of the heat sink, you have to spread out the area of the heat sink to compensate for the reduced height. Test #1 uses a 1.2" height heat sink that is the same size as the package. Test #4 was able to produce the same case temperature with a shorter heat sink and more area.

Test #5 demonstrates that a fan/heat sink assembly can spot cool effectively if you have enough space above and around it to allow the required back pressure. This is the only active device tested. If you look back at the "A Universe of Solutions to Thermal Management Problems" (Figure A-7) chart you will see the reason why. While the Pentium processor is at the outer envelope of passive cooling, this method of cooling still offers lower cost, power usage and reliability in most cases.

Most of all the system designer should **never lose sight of the real goal which is to keep the junction temperature within the operating limit**. Since the designer cannot measure junction temperature they must use the case temperature, which can be measured to ensure proper operation for the component.

Table A-9

Test #	Heat Sink Size, Inches H x W	Temperature, degrees C			I _{CC} Amps	Air Flow LFM
		Room T _A	System T _A	Case T _C		
1	1.2 x 2.1 sq.	23	29	55.3	1.82	100–150
2	0.5 x 2.1 sq.	22	29	58.3	1.81	100–150
3	0.5 x 2.1 sq.	23	27	70.3	1.81	175–200
4	0.65 x 3.1 sq.	23	29	55.3	1.8	100–140
5	HS/Fan	23	29	46	1.8	120–160

V_{CC} = 4.85V for all tests.

APPENDIX B HEAT SINK VENDORS

Aavid Engineering

One Kool Path
P.O. Box 400
Laconia, NH 03247
(603) 528-3400
(603) 525-1478 (FAX)

Contact: Gary F. Kuzmin (Product Marketing
Manager)

EG&G Wakefield Engineering

60 Audubon Rd.
Wakefield, MA 01880
(617) 245-5900
(617) 246-0874 (FAX)

Contact: David Saums (Marketing Manager)

IERC

135 W. Magnolia Blvd.
Burbank, CA 91502
(818) 842-7277
(818) 848-8872 (FAX)

Contact: Guy R. Addis (Western Region Applications
Engineer)

Thermalloy

2021 W. Valley View Lane
Dallas, TX 75234-8993
(214) 243-4321

Contact: Larry Tucker (VP of Sales and Marketing)